

# POWER NETWORK ANALYZER **ND45**



USER'S MANUAL



## Table of contents

1. General Specification .....	6
1.1. Features of the Device .....	6
1.1.1. Operational safety .....	10
1.1.1.1 Warning and Information Signs .....	11
1.1.1.2 Operating Safety .....	11
1.1.1.3 Remarks Concerning the Analyzer Installation .....	11
1.1.1.4 Precautions in the ESD Protection Range .....	12
1.2.1. Connection diagrams .....	13
1.2.1.1. Measurement signals .....	14
1.2.1.2. Communication interfaces .....	18
1.2.1.3. Card - 8 relay outputs .....	18
1.2.1.4. Card - 6 binary inputs, 4 relay outputs .....	19
1.2.1.5. Card - 6 binary inputs, 3 analog outputs .....	20
1.2.1.6. Card - 4 binary inputs, 6 analog outputs .....	21
1.2.2. Installation .....	22
2. Operation of the device .....	24
2.1. Main Screen .....	26
2.1.1. Navigation .....	28
2.1.2. Functionality .....	30
2.2. Control Panel .....	31
2.2.1. Navigation .....	32
2.2.2. Functionality .....	33
2.3. Screens and views of data presentation .....	35
2.3.1. Signs and colors of measurement parameters .....	36
2.3.2. Navigation .....	36
2.3.3. Functionality .....	38
2.3.3.1. Large digital view .....	39
2.3.3.2. Analog indicators .....	40
2.3.3.3. Trends .....	41
2.3.3.4. Harmonics and interharmonics .....	42
2.3.3.5. Energy .....	44
2.3.3.6. Vector diagrams .....	45
2.3.3.7. Waveform .....	46
2.3.3.8. Temperature / resistance .....	47
2.3.3.9. Binary inputs .....	48
2.3.3.10. Logs .....	49
2.4. Software update .....	50
3. Web server management .....	51
3.1. Navigation .....	52
3.2. Functionality .....	54
3.2.1 Login / Logout .....	54
3.2.2 Reboot device .....	55
3.2.3 Configuration of the User measurement data sets .....	55
3.2.4 Preview of measurement data .....	56
3.2.5 Selection of defined sets .....	56
3.2.6 Selection of User sets .....	57
3.2.7 Change of measurement data refresh time .....	58
3.2.8 Disabling the measurement data refresh .....	58

3.2.9 Preview of alarms .....	58
3.2.10 Confirmation of alarms.....	59
3.2.11 Preview of files .....	59
3.2.12 File list refresh .....	60
3.2.13 Opening and closing directories .....	60
3.2.14 Downloading files.....	61
3.2.15 Deleting files.....	61
3.2.16 Setting configuration from a file .....	61
3.2.17 Displaying the file contents .....	62
3.2.18 Downloading the current configuration.....	62
3.2.19 Sending a file .....	63
3.2.20 Preview of archive files .....	64
3.2.21 Preview of system information.....	65
4. FTP server management.....	66
4.1. Navigation .....	66
5. Configuration of the device parameters .....	67
5.1. Configuration management .....	67
5.2. Configuration of general settings .....	70
5.2.1. Basic parameters.....	70
5.2.2. LCD settings .....	71
5.3. Configuration of measurement input.....	73
5.3.1. General settings .....	73
5.3.2. Voltage transformer ratio .....	74
5.3.3. Current transformer ratio .....	75
5.3.4. Current direction.....	76
5.3.5. Temperature and resistance.....	77
5.3.7. External counters.....	78
5.4. Configuration of alarms .....	79
5.4.1. General settings .....	80
5.4.2. Control.....	82
5.4.3. E-mail .....	83
5.5. Configuration of visualization screens .....	84
5.5.1. Screens.....	84
5.5.2. Trends .....	85
5.6. Configuration of Ethernet.....	86
5.6.1. General settings .....	86
5.6.2. FTP and WWW Servers Settings.....	87
5.6.3. Mail client settings.....	88
5.6.3.1 SMTP configuration.....	88
5.6.4. E-mail .....	88
5.7. Configuration of Modbus .....	89
5.7.1 Configuration of Modbus RTU.....	89
5.7.2 Configuration of Modbus TCP .....	90
5.8. Configuration of archiving .....	91
5.8.1. General settings.....	91
5.8.2. Parameters.....	92
5.9. Configuration of safety rules .....	94
5.10. Configuration of power quality .....	95
5.11. Resetting the counters .....	98
5.12. Tariff configuration .....	99

5.13. Configuration of outputs .....	101
5.13.1. Analog outputs.....	102
5.11.2. Relays.....	103
6. File manager.....	104
7. Configuration of WWW.....	105
8. Configuration of FTP.....	105
9. Data archiving.....	106
10. Alarms.....	107
11. Construction.....	112
11.1. Screen.....	113
11.2. RS485 Interface.....	113
11.3. Ethernet Interface.....	115
11.4. USB Interface.....	116
11.5. SD memory card.....	116
12. Technical data.....	117
12.1. Measurements.....	117
12.2. Extension cards.....	123
12.2.1 Analog outputs.....	123
12.2.2 6 galvanically isolated binary inputs.....	123
12.2.3 Binary inputs.....	123
12.2.4. Alarm outputs.....	124
12.3. Reference conditions and rated operating conditions.....	124
12.4. Operating safety according to EN 61010-1, basic insulation.....	124
12.5. Electromagnetic compatibility.....	125
12.6. Assembly.....	125
12.7. Conformity with standards.....	125
12.8. Tables of registers.....	125
12.8.1. Information and status registers.....	126
12.8.2. CMD commands.....	127
12.8.3. Status registers.....	128
12.8.4. Parameters measured with aggregation of 200 ms.....	129
12.8.5. Parameters measured with aggregation of 1 s.....	132
12.8.6. Parameters measured with aggregation of 3 s.....	135
12.8.6. Parameters measured with aggregation of 10 min.....	136
12.8.8. Parameters measured with aggregation of 2 hours.....	140
12.8.9. Parameters averaged in time (Demand).....	143
12.8.10. Frequency, temperature/resistance.....	144
12.8.11. Flicker.....	144
12.8.12. Statuses of binary inputs.....	144
12.8.13. Energy meters.....	145
12.8.14. THD, THDS, THDG and PWHD registers.....	147
12.8.15. Harmonics registers.....	148
12.8.16. Interharmonics registers.....	149
12.8.17. Voltage half-waves registers.....	150
12.8.18. Dips/swells/increases registers.....	151
12.8.19. Pulse and energy counters from the external card.....	158
12.8.20. Tariffs.....	159
13. Ordering codes.....	167

Table of class A parameters

Measured value	Aggregation	Measurement range	Basic error	Remarks
<b>Voltage RMS</b>				
Urms L1	3s	$U_n = U_{din} = 230 \text{ V}$ : 23,0...345,0 V ( $K_u = 1$ ) ...1,38 MV ( $K_u \neq 1$ ) <sup>2</sup> $U_n = U_{din} = 57,7 \text{ V}$ : 5,7...86,5 V ( $K_u = 1$ ) ...280 kV ( $K_u \neq 1$ ) <sup>2</sup>	$\pm 0.1\% U_{din}$	<b>Class A</b>
Urms L2				
Urms L3				
Uavg L123				
<b>Half-wave voltage value</b>				
Uhalf1 L1 ... Uhalf24 L1	200ms	$U_n = U_{din} = 230 \text{ V}$ : 23,0...345,0 V ( $K_u = 1$ ) ...1,38 MV ( $K_u \neq 1$ ) <sup>2</sup> $U_n = U_{din} = 57,7 \text{ V}$ : 5,7...86,5 V ( $K_u = 1$ ) ...280 kV ( $K_u \neq 1$ ) <sup>2</sup>	$\pm 0.2\% U_{din}$	<b>Class A</b>
Uhalf1 L2 ... Uhalf24 L2				
Uhalf1 L3 ... Uhalf24 L3				
<b>Voltage harmonics</b>				
Har1 UL1 ... Har51 UL1	1s	0.00...100.00%	$U_m \geq 1\% U_{nom} \pm 5\% U_m$ $U_m < 1\% U_{nom} \pm 0.05\% U_{nom}$	<b>Class I</b>
Har1 UL2 ... Har51 UL2				
Har1 UL2 ... Har51 UL2				
Har1 UL3 ... Har51 UL3				
<b>Current RMS</b>				
Irms L1	3s	$I_n = 5 \text{ A} : 0.050...7.5 \text{ A} (K_i = 1)$ ...150.0 kA ( $K_i \neq 1$ ) $I_n = 1 \text{ A} : 0.010...1.5 \text{ A} (K_i = 1)$ ...30.0 kA ( $K_i \neq 1$ )	$\pm 0.1\% I_n$	<b>Class A</b>
Irms L2				
Irms L3				
Iavg L123				
<b>Current harmonics</b>				
Har1 IL1 ... Har51 IL1	1s	0.00...100.00%	$I_m \geq 3\% I_{nom} \pm 5\% I_m$ $I_m < 3\% I_{nom} \pm 0,15\% I_n$	<b>Class I</b>
Har1 IL2 ... Har51 IL2				
Har1 IL3 ... Har51 IL3				

- Basic error with respect to the  $U_{din}$  value acc.to EN-61000-4-30.
- Range  $K_u = 1 \dots 4000.0$  and  $K_i = 1 \dots 20,000.0$ .
- $U_{din}$  - value obtained from the declared supply voltage  $U_c = U_n$  by the transformer ratio, according to EN-61000-4-30.
- $I_m, U_m$  – measured values of currents and voltages according to EN-61000-4-7.
- $I_{nom}, U_{nom}$  – nominal values of currents and voltages according to EN-61000-4-7.
- $I_n, U_n$  – nominal values of currents and voltages according to EN-61000-4-30.

## 1. General Specification

ND45 Analyzer is designed for the measurement and analysis of three-phase, 3- or 4-wire power network parameters in balanced or unbalanced systems.

Complete set of the Analyzer includes:

- ND45 Meter 1 pc
- User's Manual - Quick Start 1 pc
- mounting brackets to fix the device in the panel 4 pcs
- key 1 pc
- ferrite filter STAR-TEC 74271132 1 pc
- SD card 1 pc

As an optional accessory for the ND45 analyzer you can order:

- STR receiver for time synchronization with GPS
- cable with plug to connect STR receiver with ND45 analyzer

**Caution!** On the SD card is located ND45 Setup software and user manual.

### 1.1. Features of the Device

- measurement and recording of energy quality parameters according to EN 50160 standard.
- intuitive operation of the device using a touch screen and graphical user interface based on Linux.
- color touch screen LCD TFT 5,6", 640x480 pixels
- communication interfaces : Ethernet 10/100 Base-T, Modbus TCP/IP Slave, RS-485 Modbus Slave
- all phases are separated
- IP54 casing protection on the user's side
- selection of the time zone, automatic adjustment for Daylight Saving Time, synchronization with the time server, time synchronization with GPS when connected to STR device
- data archiving on an SD card
- WWW server, FTP server
- logs of interrupts, dips, swells, alarms and audits
- Firmware update option
- language choice Polish/English
- Dedicated visualization in the form of the following displays, among others: digital, analog, harmonics, vector diagrams, trends, waveform records
- sampling frequency of the measurement card: 20480 Hz

**Measured parameters :**

<b>Voltage measurements</b>	<b>Parameters measured with aggregation of 200 ms</b>	
	RMS:	Urms L1, Urms L2, Urms L3, Uavg L123.
	Basic RMS:	Ufund L1, Ufund L2, Ufund L3, Ufavg L123.
	Phase-to-phase:	Umf L1-2, Umf L2-3, Umf L3-1, Umf avg L123.
	Asymmetry:	Vunb.
	Half wave:	Uhalf1 L1 ... Uhalf24 L1, Uhalf1 L2 ... Uhalf24 L2, Uhalf1 L3 ... Uhalf24 L3.
	<b>Parameters measured with aggregation of 1 s</b>	
	RMS:	Urms L1, Urms L2, Urms L3, Uavg L123.
	Basic RMS:	Ufund L1, Ufund L2, Ufund L3, Ufavg L123.
	Phase-to-phase:	Umf L1-2, Umf L2-3, Umf L3-1, Umf avg L123.
	Asymmetry:	Vunb.
	Harmonics:	Har1 UL1 ... Har51 UL1, Har1 UL2 ... Har51 UL2, Har1 UL3 ... Har51 UL3.
	Interharmonics	IHar1 UL1 ... IHar51 UL1, IHar1 UL2 ... IHar51 UL2, IHar1 UL3 ... IHar51 UL3.
	Distortion factor:	THD U L1, THD U L2, THD U L3, THD Uavg L123.
	Distortion factor of Harmonic Groups:	THDS U L1, THDS U L2, THDS U L3, THDS Uavg L123.
	Distortion factor of Harmonic Sub-groups:	THDG U L1, THDG U L2, THDG U L3, THDG Uavg L123.
	Partially weighted distortion factor:	PWHD U L1, PWHD U L2, PWHD U L3, PWHD Uavg L123.
	<b>Parameters measured with aggregation of 3 s</b>	
	RMS:	Urms L1, Urms L2, Urms L3, Uavg L123.
	Basic RMS:	Ufund L1, Ufund L2, Ufund L3, Ufavg L123.
	Phase-to-phase:	Umf L1-2, Umf L2-3, Umf L3-1, Umf avg L123.
	Asymmetry:	Vunb.
	<b>Parameters measured with aggregation of 10 min.</b>	
	RMS:	Urms L1, Urms L2, Urms L3, Uavg L123.
	Basic RMS:	Ufund L1, Ufund L2, Ufund L3, Ufavg L123.
	Phase-to-phase:	Umf L1-2, Umf L2-3, Umf L3-1, Umf avg L123.
	Asymmetry:	Vunb.
	<b>Parameters measured with aggregation of 2 hours</b>	
	RMS:	Urms L1, Urms L2, Urms L3, Uavg L123.
	Basic RMS:	Ufund L1, Ufund L2, Ufund L3, Ufavg L123.
	Phase-to-phase:	Umf L1-2, Umf L2-3, Umf L3-1, Umf avg L123.
	Asymmetry:	Vunb.
<b>The values averaged for 15 min, 30 min or 1 hour.</b>		
Demand	U Demand	

<b>Current measurements</b>	<b>Parameters measured with aggregation of 200 ms</b>	
	RMS:	Irms L1, Irms L2, Irms L3, Iavg L123.
	Neutral:	In.
	Calculated neutral:	INC.
	<b>Parameters measured with aggregation of 1 s</b>	
	RMS:	Irms L1, Irms L2, Irms L3, Iavg L123.
	Neutral:	In.
	Calculated neutral:	INC.
	Harmonics:	Har1 IL1 ... Har51 IL1, Har1 IL2 ... Har51 IL2, Har1 IL3 ... Har51 IL3.
	Distortion factor:	THD I L1, THD I L2, THD I L3, THD Iavg L123.
	Distortion factor of Harmonic Groups:	THDS I L1, THDS I L2, THDS I L3, THDS Iavg L123.
	Distortion factor of Harmonic Sub-groups:	THDG I L1, THDG I L2, THDG I L3, THDG Iavg L123.
	Partially weighted distortion factor:	PWHD I L1, PWHD I L2, PWHD I L3, PWHD Iavg L123.
	<b>Parameters measured with aggregation of 3 s</b>	
	RMS:	Irms L1, Irms L2, Irms L3, Iavg L123.
	Neutral:	IN.
	Calculated neutral:	INC.
	<b>Parameters measured with aggregation of 10 min.</b>	
	RMS:	Irms L1, Irms L2, Irms L3, Iavg L123.
	Neutral:	In.
	Calculated neutral:	INC.
	<b>Parameters measured with aggregation of 2 hours</b>	
	RMS:	Irms L1, Irms L2, Irms L3, Iavg L123.
	Neutral:	In.
	Calculated neutral:	INC.
	<b>Averaged values for 15 min, 30 min or 1 hour</b>	
	Demand	U Demand
<b>Power and energy measurements</b>	<b>Parameters measured with aggregation of 200 ms</b>	
	Active imported energy	EnP+ L1, EnP+ L2, EnP+ L3, $\sum$ EnP+ L123.
	Active exported energy	EnP- L1, EnP- L2, EnP- L3, $\sum$ EnP- L123.
	Reactive inductive energy	EnQ{ L1, EnQ{ L2, EnQ{ L3, $\sum$ EnQ{ L123.
	Reactive capacity energy	EnQ-+L1, EnQ-+L2, EnQ-+L3, $\sum$ EnQ-+L123.
	Apparent energy	EnS L1, EnS L2, EnS L3, $\sum$ EnS L123.
	Active power	P L1, P L2, P L3, Pavg L123, $\sum$ P L123.
	Reactive power	Q L1, Q L2, Q L3, Qavg L123, $\sum$ Q L123.
	Apparent power	S L1, S L2, S L3, Savg L123, $\sum$ S L123.
	<b>Parameters measured with aggregation of 1 s</b>	
	Active power	P L1, P L2, P L3, Pavg L123, $\sum$ P L123.
	Reactive power	Q L1, Q L2, Q L3, Qavg L123, $\sum$ Q L123.



	Apparent power	$S L1, S L2, S L3, Savg L123, \Sigma S L123.$	
	Parameters measured with aggregation of 3 s		
	Active power	$P L1, P L2, P L3, Pavg L123, \Sigma P L123.$	
	Reactive power	$Q L1, Q L2, Q L3, Qavg L123, \Sigma Q L123.$	
	Apparent power	$S L1, S L2, S L3, Savg L123, \Sigma S L123.$	
	Parameters measured with aggregation of 10 min.		
	Active power	$P L1, P L2, P L3, Pavg L123, \Sigma P L123.$	
	Reactive power	$Q L1, Q L2, Q L3, Qavg L123, \Sigma Q L123.$	
	Apparent power	$S L1, S L2, S L3, Savg L123, \Sigma S L123.$	
	Parameters measured with aggregation of 2 hours		
	Active power	$P L1, P L2, P L3, Pavg L123, \Sigma P L123.$	
	Reactive power	$Q L1, Q L2, Q L3, Qavg L123, \Sigma Q L123.$	
	Apparent power	$S L1, S L2, S L3, Savg L123, \Sigma S L123.$	
	Averaged values for 15 min, 30 min or 1 hour		
	Demand	P Demand, Q Demand, S Demand.	
	Other parameters	Parameters measured with aggregation of 200 ms	
		Power distortion factor:	$dPF L1, dPF L2, dPF L3, dPFavg L123.$
		Active power factor:	$PF L1, PF L2, PF L3, PFavg L123.$
		tgφ factor:	$tg\phi L1, tg\phi L2, tg\phi L3, tg\phi avg L123.$
		The angle between the voltage and current:	$\phi L1, \phi L2, \phi L3, \phi avg L123.$
Voltage phase-to-phase angle:		$\alpha U L1-2, \alpha U L2-3, \alpha U L3-1.$	
Parameters measured with aggregation of 1 s			
Power distortion factor:		$dPF L1, dPF L2, dPF L3, dPFavg L123.$	
Active power factor:		$PF L1, PF L2, PF L3, PFavg L123.$	
tgφ factor:		$tg\phi L1, tg\phi L2, tg\phi L3, tg\phi avg L123.$	
The angle between the voltage and current:		$\phi L1, \phi L2, \phi L3, \phi avg L123.$	
Voltage phase-to-phase angle:		$\alpha U L1-2, \alpha U L2-3, \alpha U L3-1.$	
Frequency		f	
Parameters measured with aggregation of 3 s			
Power distortion factor:		$dPF L1, dPF L2, dPF L3, dPFavg L123.$	
Active power factor:		$PF L1, PF L2, PF L3, PFavg L123.$	
tgφ factor:		$tg\phi L1, tg\phi L2, tg\phi L3, tg\phi avg L123.$	
The angle between the voltage and current:		$\phi L1, \phi L2, \phi L3, \phi avg L123.$	
Voltage phase-to-phase angle:		$\alpha U L1-2, \alpha U L2-3, \alpha U L3-1.$	
Parameters measured with aggregation of 10 s			
Frequency		f	
Parameters measured with aggregation of 10 s			
Flicker		Pst L1 (1 min), Pst L2 (1 min), Pst L3 (1 min)	
Parameters measured with aggregation of 10 min.			
Power distortion factor:		$dPF L1, dPF L2, dPF L3, dPFavg L123.$	

	Active power factor:	PF L1, PF L2, PF L3, PFavg L123.
	tgφ factor:	tgφ L1, tgφ L2, tgφ L3, tgφavg L123.
	The angle between the voltage and current:	φ L1, φ L2, φ L3, φavg L123.
	Voltage phase-to-phase angle:	α U L1-2, α U L2-3, α U L3-1.
	Flicker	Pst L1, Pst L2, Pst L3
	Parameters measured with aggregation of 2 hours	
	Power distortion factor:	dPF L1, dPF L2, dPF L3, dPFavg L123.
	Active power factor:	PF L1, PF L2, PF L3, PFavg L123.
	tgφ factor:	tgφ L1, tgφ L2, tgφ L3, tgφavg L123.
	The angle between the voltage and current:	φ L1, φ L2, φ L3, φavg L123.
	Voltage phase-to-phase angle:	α U L1-2, α U L2-3, α U L3-1.
	Flicker	Plt L1, Plt L2, Plt L3
	Parameters measured with aggregation of 1 s	
	Temperature / Resistance	T1, T2.





### 1.1.1. Operational safety

**Caution!** Removal of the meter casing during the warranty period voids the warranty.

- The assembly and the installation of the electrical connections may be carried out only by a duly qualified electrician.
- Always check the connections before turning the meter on.
- Prior to removing the analyzer housing, always turn the supply off and disconnect the measurement circuits.
- The device is intended for installation and use in industrial electromagnetic environments.
- A switch or a circuit-breaker should be installed in the building or facility. It should be located near the device, easily accessible to the operator, and suitably marked.

### 1.1.1.1 Warning and Information Signs

One or more of presented symbols can be used in the device or user's manual:

	Caution: pay special attention to the description in the analyzer user's manual.
	Terminal of the protection lead
	Caution: High voltage
	Terminal of the protection lead
	Waste of electrical and electronic equipment (WEEE). Don't dispose among generic waste but collect separately for recycling and disposal operations according by law.

### 1.1.1.2 Operating Safety

In the safety operating scope, the ND45 Power Analyzer meets requirements related to safety of electrical measuring instruments for automation, acc. to EN 61010-1 standard and requirements concerning the immunity against noises occurring in industrial environments acc. to EN 61000-6-2 and EN 61000-6-4 standards.

The improper connection of the supply, communication interfaces and measuring signals, and the use of equipment inconsistent with the description included in the present user's manual and standards as above, can cause serious damage of the analyzer.

A switch or a circuit -breaker should be located near the device, easy accessible by the operator and suitable marked.

### 1.1.1.3 Remarks Concerning the Analyzer Installation

Various sources of noise occurring in practice interact with the ND45 Power Analyzer in a continuous or pulse way from the supply network side (as the result of the action of other devices) and also overlap on the measured signal or auxiliary circuits of the analyzer. In particular, strong pulse noises are dangerous for the device operation since they can cause sporadic erroneous measurement results or accidental operations of alarms. The level of these noises should be reduced

to a value lower than the immunity threshold of the analyzer, first of all through a suitable installation of the analyzer in the object.

In this scope, it is recommended to observe following recommendations:

- Do not supply the analyzer from networks near devices generating high pulse noises in the supply network and do not use common grounding circuits with them.
- Signaling wires must be shielded.
- Lead connections of binary input circuits, individually in shields as above, by means of twisted wires.
- Connections of communication interface circuits, lead individually in shields as above and by means of twisted wires.
- All shields should be earthed unilaterally near the analyzer.
- A common earth conductor with other devices must be avoided.
- Apply the general principle that wires (group of wires) leading different signals should be led in the longest possible distance between them and crossings of such groups of wires should be made at a 90° angle.
- When connecting the supply, please remember that a switch or a circuit-breaker should be installed in the room. This switch should be located near the analyzer, easy accessible by the operator and suitably marked as an element switching the analyzer off.
- It is not allowed to remove the analyzer casing.
- All operations concerning transport, installation, and commissioning as well as maintenance, must be carried out by qualified, skilled personnel, and national regulations for the prevention of accidents must be observed.
- Protections ensuring the device safety can be less effective in case of exploitation inconsistent with manufacturer's indications and principles of a good engineering practice.
- Set on the supply cable (near the recorder) a ferrite filter STAR-TEC 74271132 being in the recorder accessory set.

#### **1.1.1.4 Precautions in the ESD Protection Range**

Semiconductor elements or packages used in the analyzer design, can be damaged in result of electrostatic discharges (ESD). In order to prevent this, you must observe following recommendations during service works:

- Disassemble instruments only in the area protected against electrostatic discharges.
- Use conductive materials to dissipate electrostatic charges in the working area.
- Use only antielectrostatic packings to store electronic elements and packages.
- Do not touch elements and packages with hands.
- Do not keep materials susceptible to generate electrostatic charges in the working area.

1.2.1. Connection diagrams

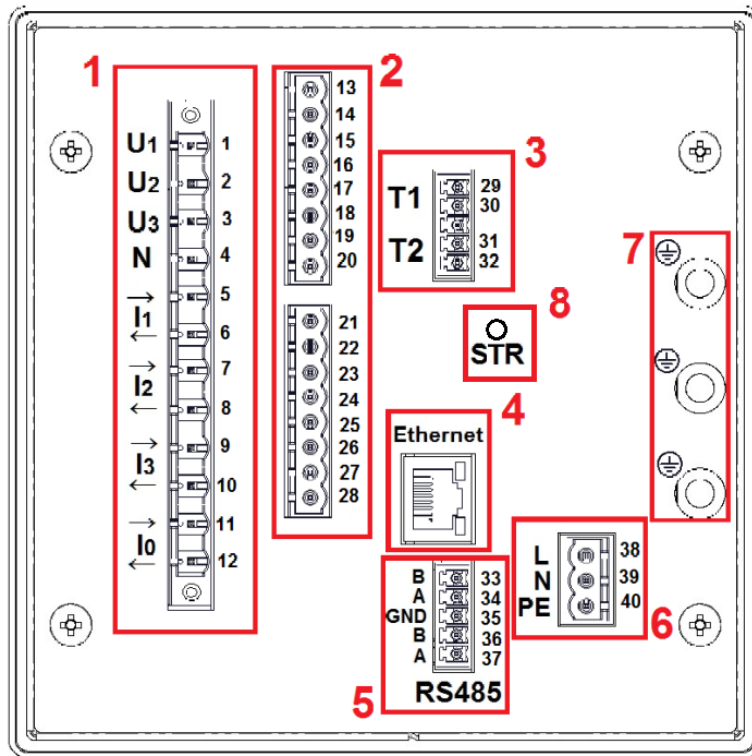

Fig. 1. Terminal plate.

Component	Description
1	Measurement output of electrical parameters.
2	Additional inputs/outputs - optional equipment depending on ND45 execution code. There are relay outputs, binary inputs and analog outputs.
3	Measurement inputs of temperature and resistance.
4	Ethernet communication interface.
5	RS 485 Modbus Slave communication interface.
6	ND45 analyzer power supply.
7	Earth terminals for screens connection.
8	STR receiver connector for time synchronization with GPS



3-wire network. Indirect measurement using two current transformers and two or three voltage transformers.

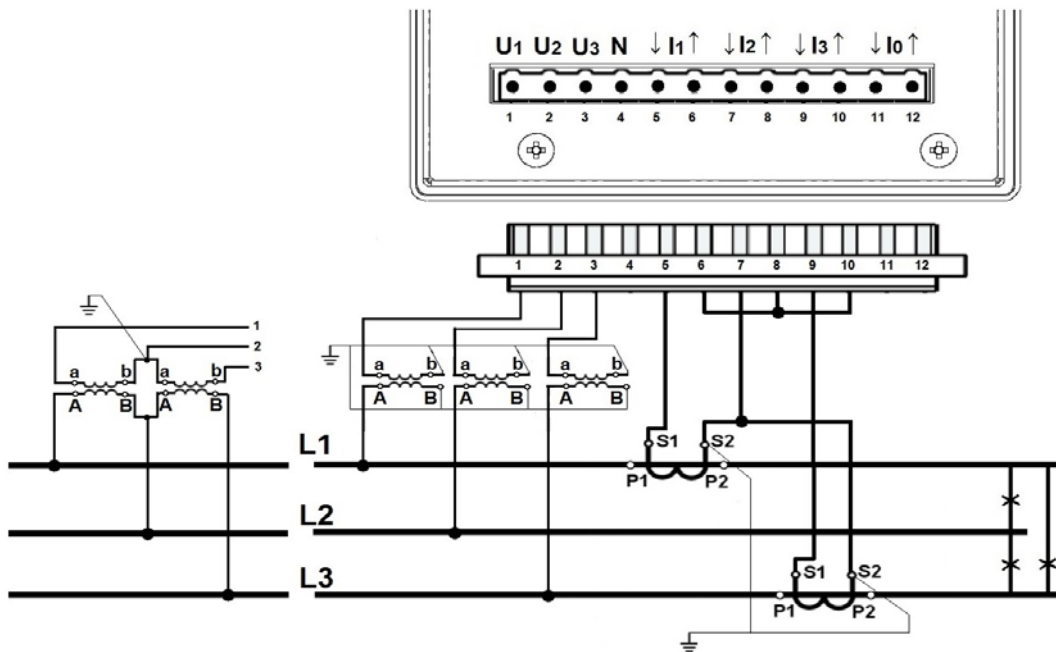

Fig. 4. Diagram - 3-wire network.

4-wire network. Direct measurement.

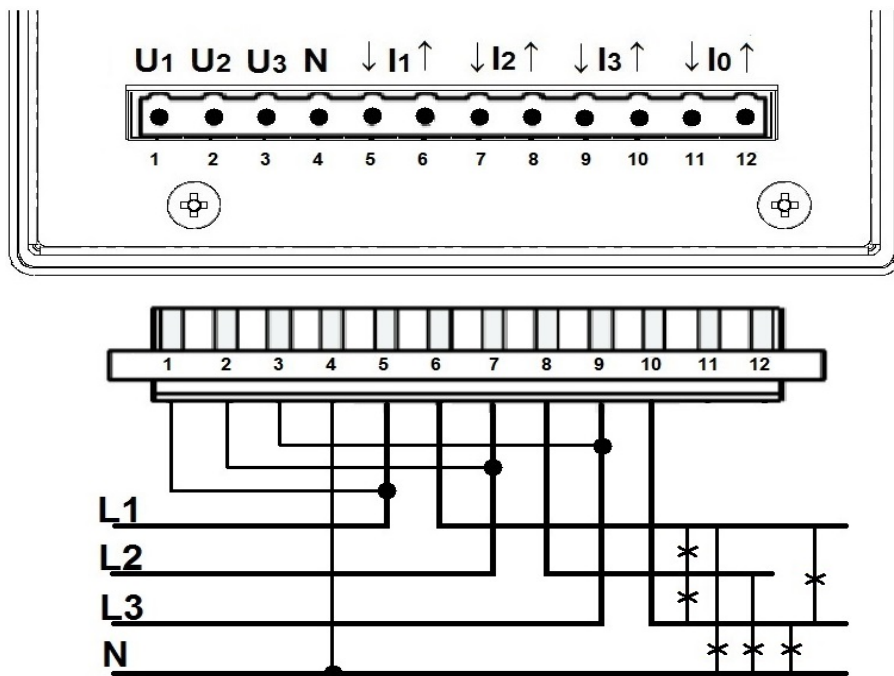

Fig. 5. Diagram - 4-wire network.

4-wire network. Semi-indirect measurement.

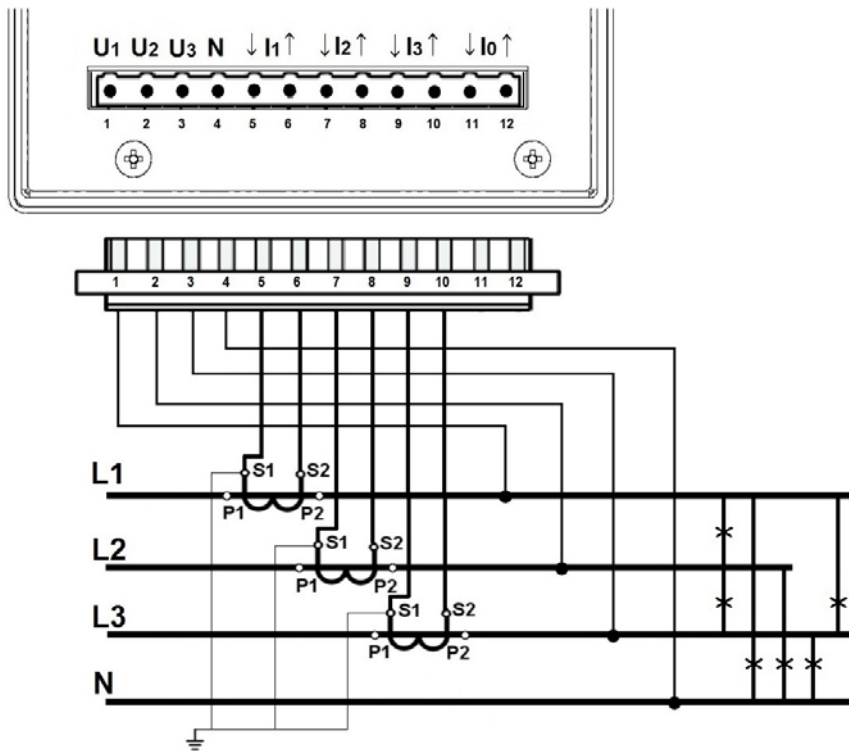

Fig.6. Diagram - 4-wire network.

4-wire network. Semi-indirect measurement using four current transformers.

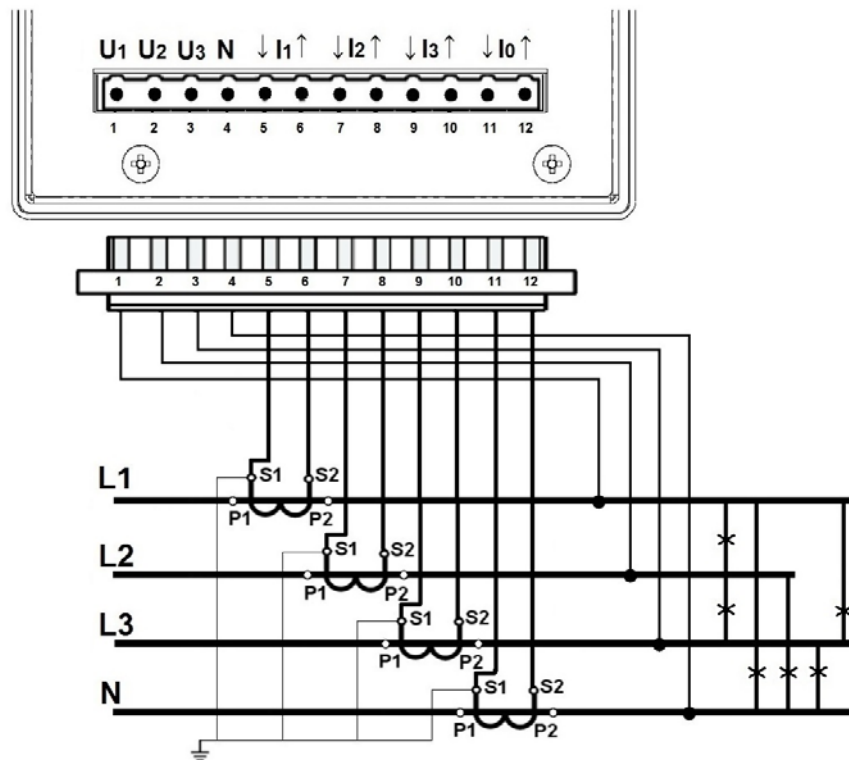

Fig. 7. Diagram - 4-wire network.



4-wire network. Indirect measurement using three current transformers and two or three voltage transformers.

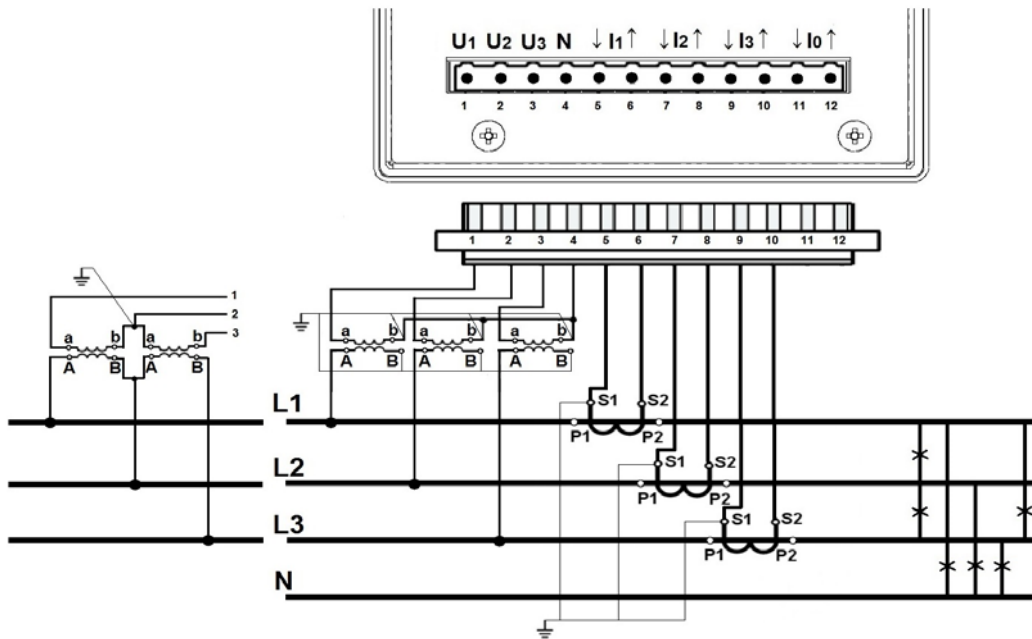

Fig. 8. Diagram - 4-wire network.

4-wire network. Indirect measurement using four current transformers and two or three voltage transformers.

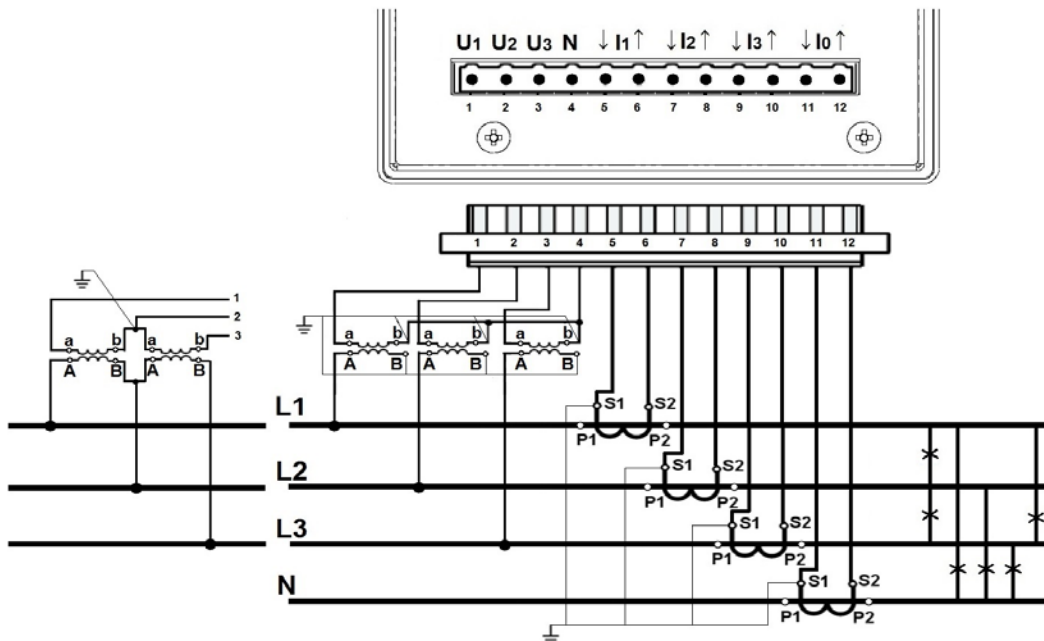

Fig. 9. Diagram - 4-wire network.

### 1.2.1.2. Communication interfaces

Ethernet (RJ45) socket.

To connect the meter to the hub (concentrator) or the switch, it is necessary to use a cable with 1:1 leads.



Fig. 10. Ethernet.

RS485 Interface (Slave) is assigned to terminal pairs 33-34 and 36-37.

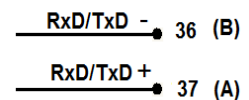
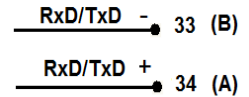

Fig. 11. Com. Interfaces

### 1.2.1.3. Card - 8 relay outputs

Relay outputs connection

Relay outputs configured as normally open (NO).

Where :

terminals 13-14: output 1, terminals 21-22: output 5,  
 terminals 15-16: output 2, terminals 23-24: output 6,  
 terminals 17-18: output 3, terminals 25-26: output 7,  
 terminals 19-20: output 4, terminals 27-28: output 8.

Version with 8 relays uses the upper and lower part of the expansion card terminal, terminals from 13 to 28.

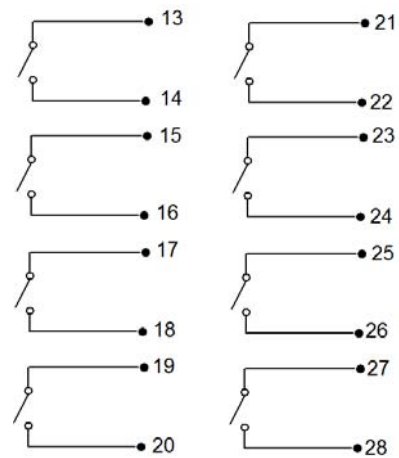

Fig. 12: Relay outputs .

### 1.2.1.4. Card - 6 binary inputs, 4 relay outputs

#### Relay outputs connection

Relay outputs configured as normally open (NO).

Where :

- terminals 13-14: output 1,
- terminals 15-16: output 2,
- terminals 17-18: output 3,
- terminals 19-20: output 4,

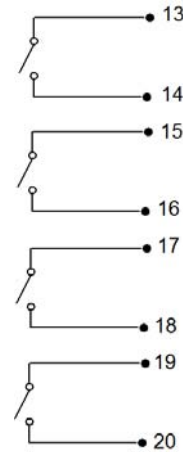

Version with 4 relays uses the upper part of the expansion card terminal, terminals from 13 to 20.

**Fig. 13: Relay outputs.**

#### Binary outputs connection

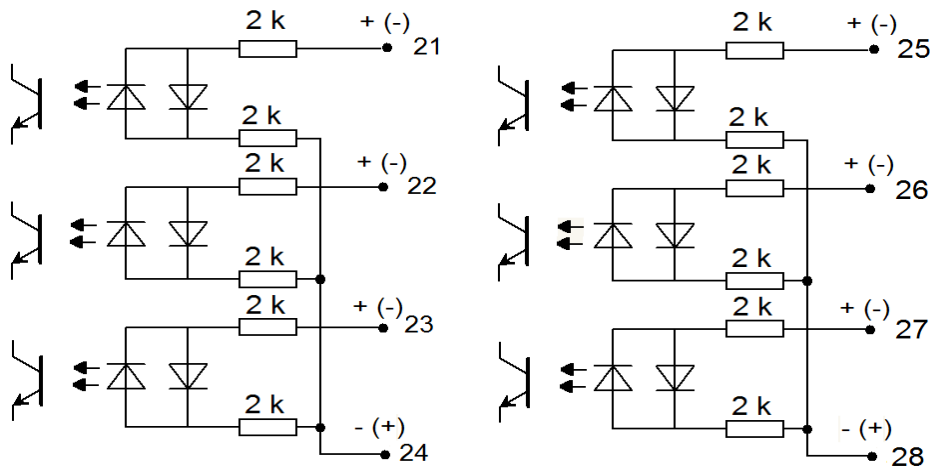

**Fig. 14: Binary inputs.**

Binary inputs BI 1...BI 6 are controlled by signals:

- 0 V dc – inactive binary input
- +5...24 V dc – input as active binary input
- +8...24 V dc – input as counting input (high level)

Where:

- terminal 21 : binary input BI 1, terminal 25 : binary input BI 4,
- terminal 22 : binary input BI 2, terminal 26 : binary input BI 5,
- terminal 23 : binary input BI 3, terminal 27 : binary input BI 6.

terminal 24: common terminal for inputs BI 1-3  
 terminal 28: common terminal for inputs BI 4-6

### 1.2.1.5. Card - 6 binary inputs, 3 analog outputs

#### Analog outputs connection

Version with analog inputs uses the upper part of the extension card terminal and includes 3 pairs of terminals :

- 13 – 14 : analog output 1 (AO1)
- 16 – 17 : analog output 2 (AO2)
- 19 – 20 : analog output 3 (AO3)

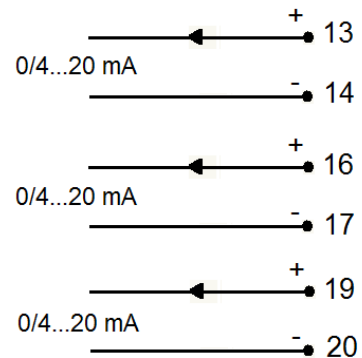

Fig.15. Analog outputs.

#### Binary inputs connections

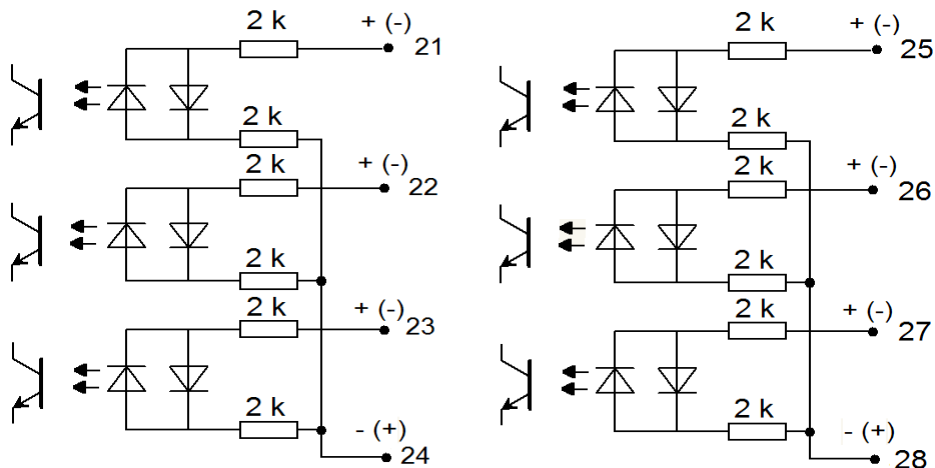

Fig. 16. Binary inputs.

- Binary inputs BI 1...BI 6 are controlled by signals :
- 0 V dc – inactive binary input
  - +5...24 V dc – active binary input
  - +8...24 V dc – input as counting input (high level)

Where:

terminal 21 : binary input BI 1, terminal 25 : binary input BI 4,

terminal 22 : binary input BI 2, terminal 26 : binary input BI 5 ,  
 terminal 23 : binary input BI 3, terminal 27 : binary input BI 6 .

terminal 24: common terminal for inputs BI 1-3  
 terminal 28: common terminal for inputs BI 4-6

### 1.2.1.6. Card - 4 binary inputs, 6 analog outputs

#### Analog outputs connection

Version with analog inputs uses both terminals of the extension card and includes 6 pairs of terminals :

13 – 14 : analog output 1 (AO1)

16 – 17 : analog output 2 (AO2)

19 – 20 : analog output 3 (AO3)

21 – 22 : analog output 4 (AO4)

24 – 25 : analog output 5 (AO5)

27 – 28 : analog output 6 (AO6)

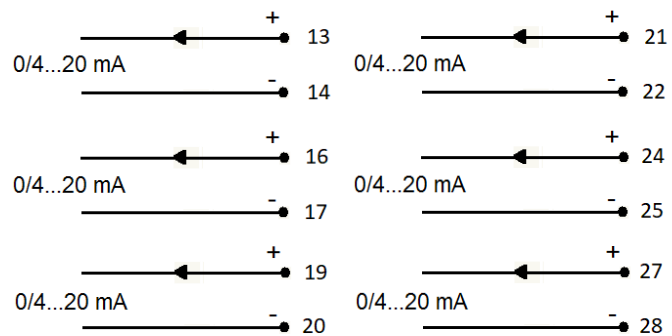

Fig. 17. Analog outputs.

#### Binary outputs connection

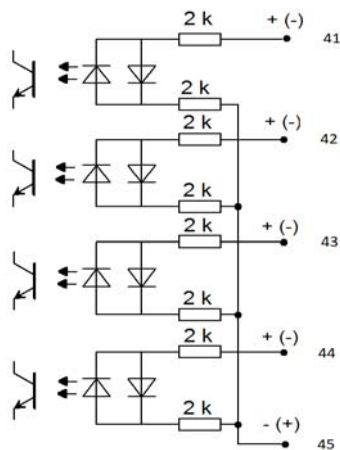

Fig. 18: Binary inputs.

Binary inputs BI 1...BI 4 are controlled by signals :

- 0 V dc – inactive binary input
- +5...24 V dc – active binary input
- +8...24 V dc – input as counting input (high level)

Where:

- terminal 41 : binary input BI 1,
- terminal 42 : binary input BI 2,
- terminal 43 : binary input BI 3,

terminal 44 : binary input BI 4,  
terminal 45: common terminal for inputs BI 1-4

### 1.2.1.7. STR receiver connector for time synchronization with GPS

Connect the STR receiver to the back panel of the analyzer using a 3.5mm Stereo Jack cable. The description of the signals in the connector is shown in Figure 18. Connect the other end of the cable to the terminals of the STR receiver, according to its operating instructions.

You can make your own cable, or order a ready-made one by contacting the manufacturer's sales department.

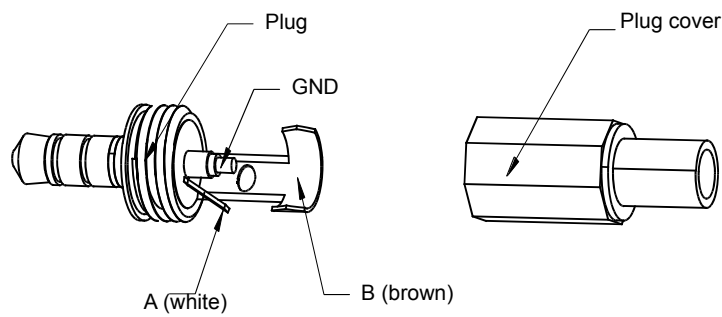

**Fig. 18. Connection of STR receiver**

## 1.2.2. Installation

ND45 analyzer can be fixed to a panel using mounting brackets. Casing dimensions 144 x 144 x 104 mm, mounting hole dimensions 138 x 138 mm.

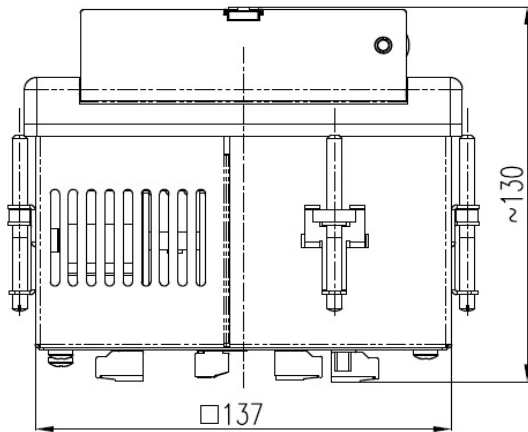

Fig. 19. Dimensions - bottom.

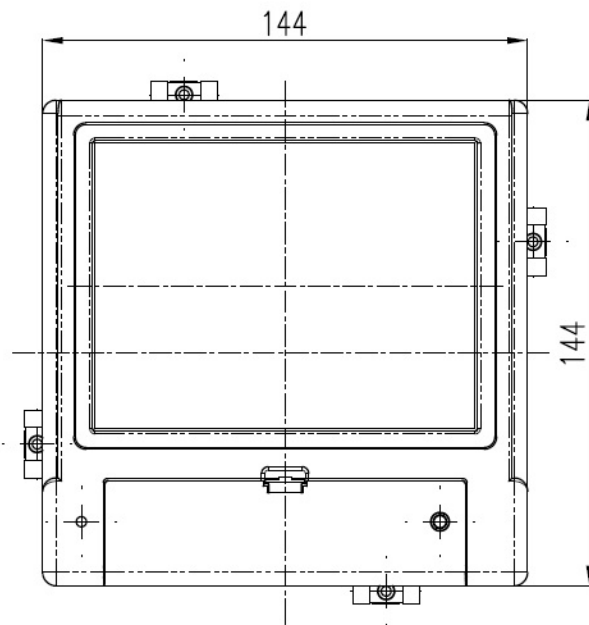

Fig. 20. Dimensions - front.

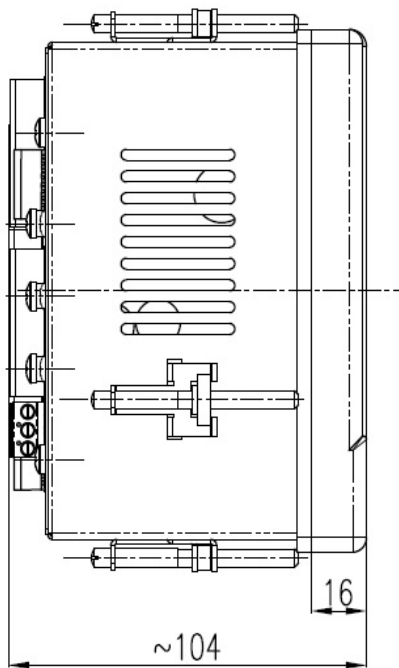

Fig. 21. Dimensions - side.

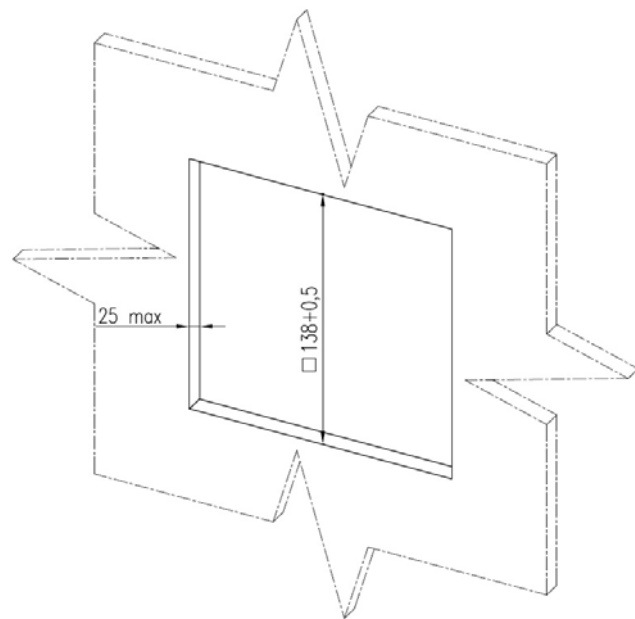

Fig. 22. Dimensions - mounting hole.

## 2. Operation of the device

View of the main editing dialog box allowing for modification of digits, characters or special characters. The example here allows entering characters (lowercase).

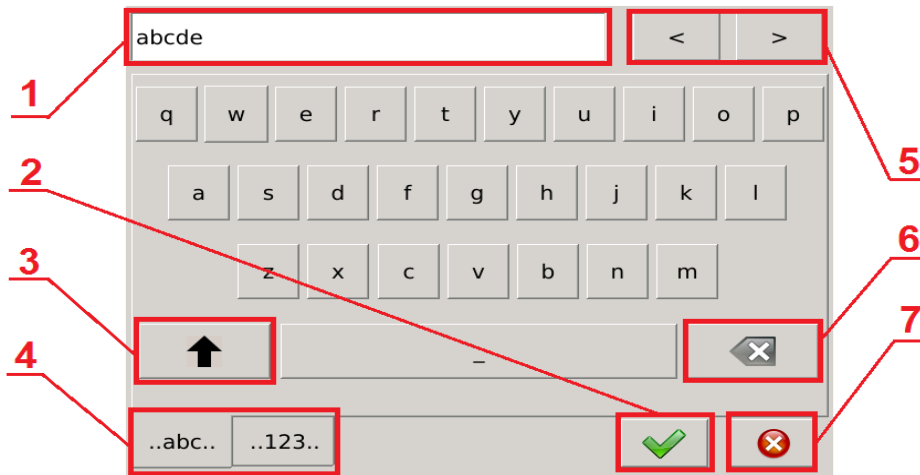

Fig. 23. Dialog box - editing, lowercase.

Item	Description
1	Display of the edited item.
2	Confirmation of the entered value and closing the dialog box.
3	Switching the keyboard between lowercase and uppercase.
4	Changing tabs between the lowercase keyboard and the keyboard with digits and special characters.
5	Buttons for moving the cursor to the left or right on the screen displaying the edited item (1).
6	Deleting a single item of the screen (1) located directly behind the cursor.
7	Closing the dialog box without saving the entered value.

View of the dialog box for entering characters (uppercase).



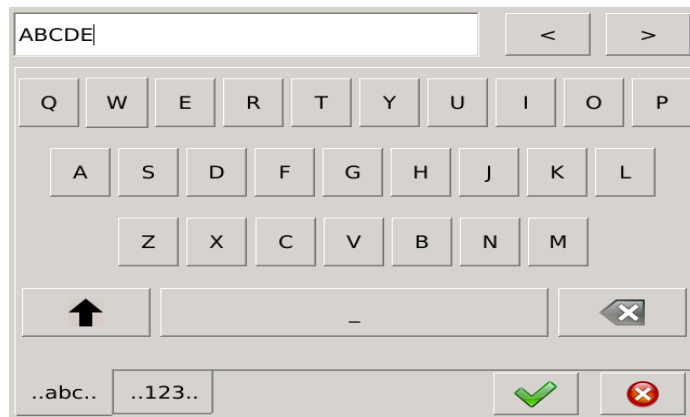

Fig.24. Dialogue - editing, uppercase.

View of the dialog box for entering numerical values and available special characters.



Fig. 25. Dialog box - editing, special characters.

Editor of numerical values *Fig.26*. The upper part contains a range of values which can be saved. This functionality allows users to enter the fixed-point values (example on the left) or floating point values (example on the right), deleting the entire screen displaying the edited value or a single digit.

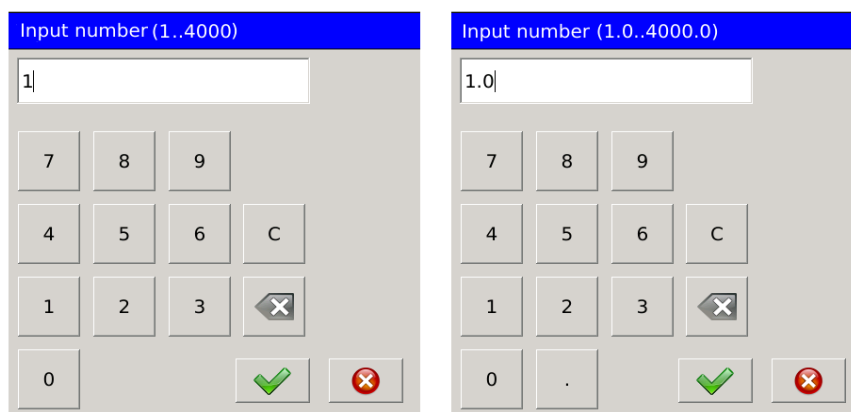

Fig. 26. Dialog box - editing, numerical values.

Multiple selection list *Fig.27* (example on the right), more than one option can be selected. To select an unselected item on the screen touch it. To cancel the selection touch the previously selected item again. Additional buttons provide the functionalities of auto-select or deselect of all the options of the list. The selection list (example on the left) allows for selection of only one of the available

options.

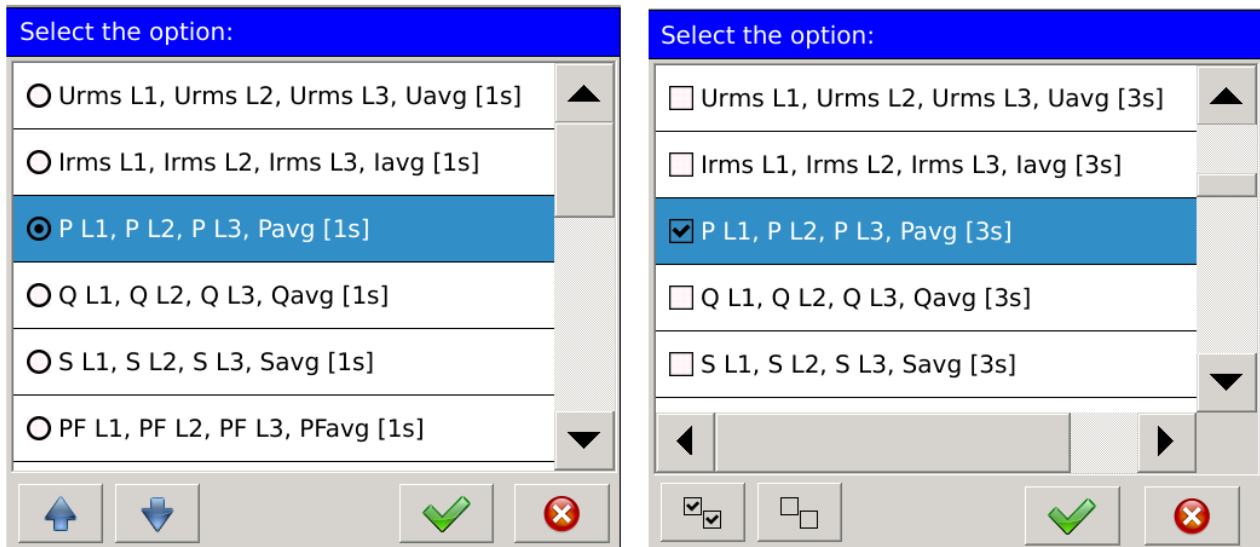

Fig. 27. Dialog box - selection, lists.

## 2.1. Main Screen

After starting the device the User will be redirected to the main screen *Fig.28*. At the start-up (for standard configuration) it will be the first screen view of digital displays showing the values aggregated with 1 s. of the individual U RMS phases and the average value.

The main screen contains elements belonging to the three groups. Access to all the elements assigned to the individual groups is possible by touching any point on the screen of the meter.

The first group consists of **navigational elements** which allow the User to change the way the measured values are presented, depending on the current configuration settings.

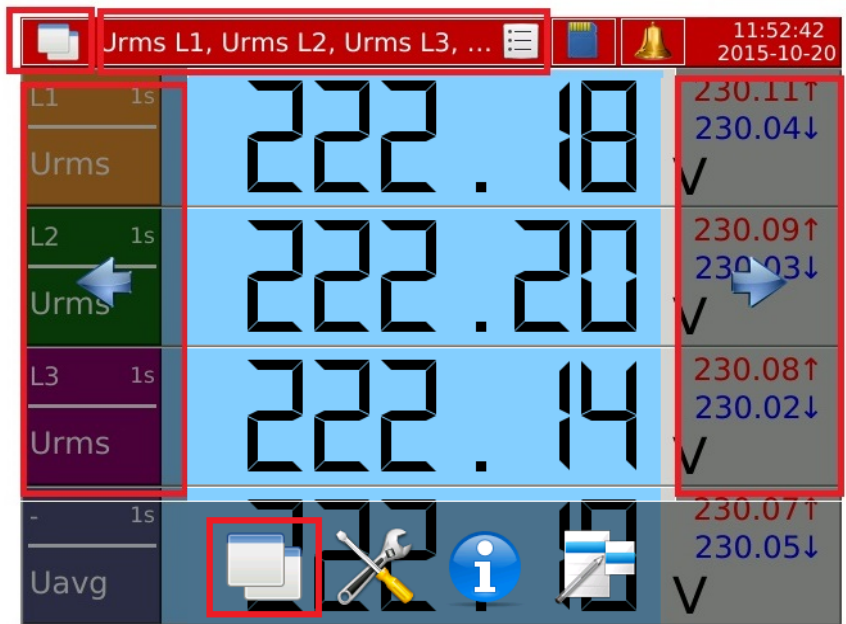

Fig. 28. Navigational elements.

Another group consists of **functional elements** which let the User change current settings of the meter and provide access to advanced configuration settings.

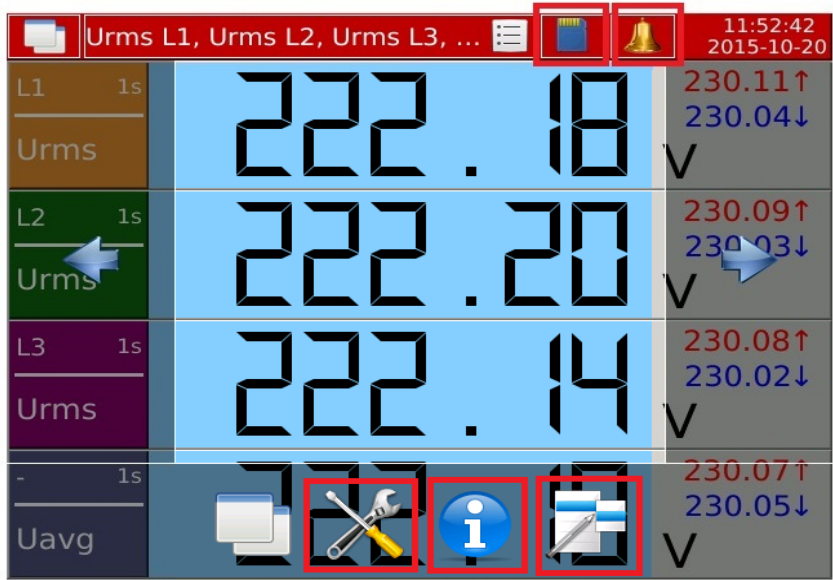

Fig. 29. Functional elements.

The last group consists of information elements which present the data available to the User.

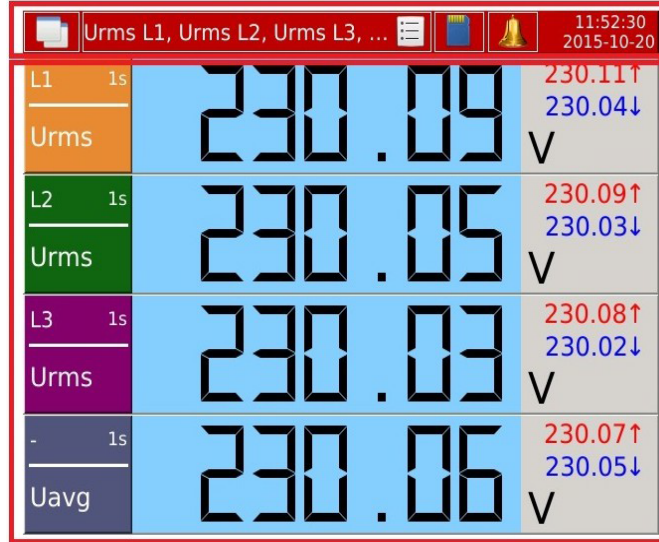

Fig. 30. Information elements.

### 2.1.1. Navigation

Pressing a finger to the screen area used for presenting the analyzer data displays a window for, among others, editing navigation.

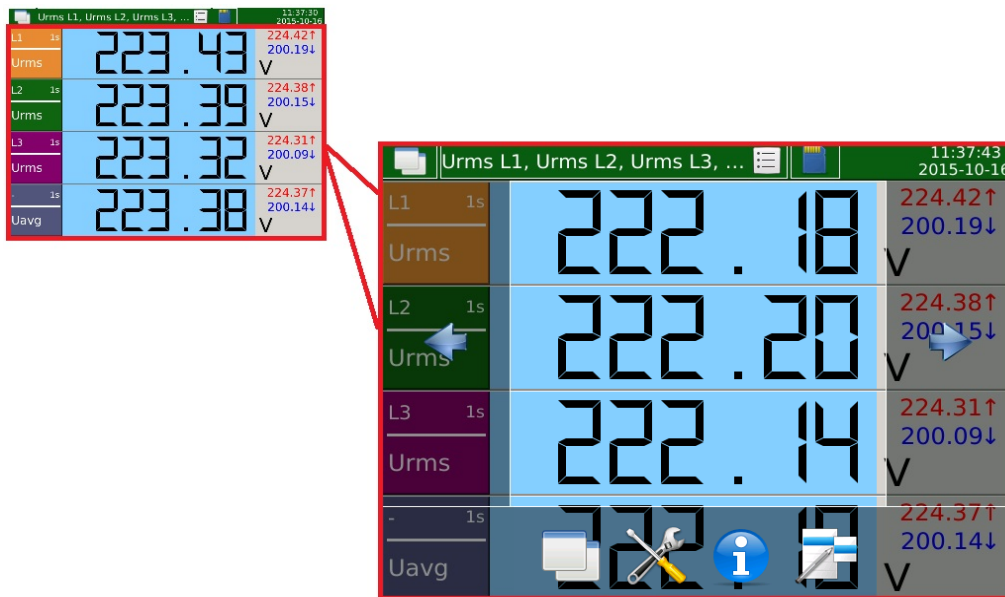

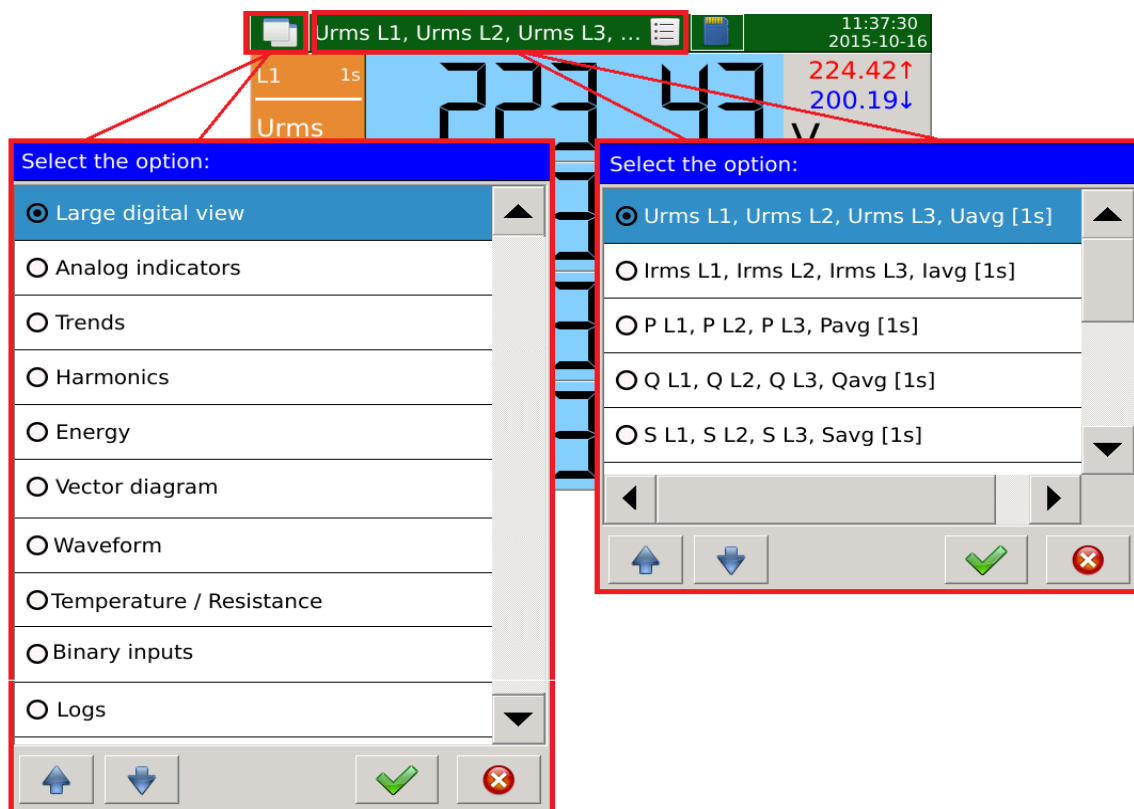

Fig. 31. Navigation - main screen.

Selected navigational elements are presented below.

Symbol	Description
 <p><b>Fig. 32. Navigation - screens.</b></p>	<p>Navigation for the currently set screen mode. The screen together with views can be individually defined for each configuration. After the right arrow is selected, the device presents other views of the screen. When the last element is reached, the selection of the option to move to the right will result in return to the first element. The option to move to the left is executed in the same way.</p>
 <p><b>Fig. 33. Navigation - views</b></p>	<p>The option to move to the next screen is assigned to the button. When this option is selected, the device displays the next available screen for this configuration and the first defined view.</p>





**Fig. 34. Navigation - switching views and screen.**

Dialog box *Fig.30* (on the left) allows for selecting one of the available screens. By using this dialog box the User can switch directly to the selected mode. The example shows the configuration settings which contain all possible screen views that can be set.

Dialog box *Fig.30* (on the right) shows an example of the selection of the view which is available for the currently selected screen mode. The example shows standard views for the selected screen (Large digital view).

### 2.1.2. Functionality

The table shows the individual elements of the main screen with the description of their functionality.

Symbol	Description
 <p><b>Fig. 35. Function - control panel.</b></p>	Access to the control panel, which manages the configurations, is protected from unauthorized access by the login window.
 <p><b>Fig. 36. Function - system information.</b></p>	Switching to the tab with system information.
 <p><b>Fig. 37. Function - context menu.</b></p>	Switching to the context menu that allows management of the selected parameters of the device. Example of a dialog box is shown below.

Options available in the context menu depend on the selected screen on which the menu was opened. The table below shows all possible options.

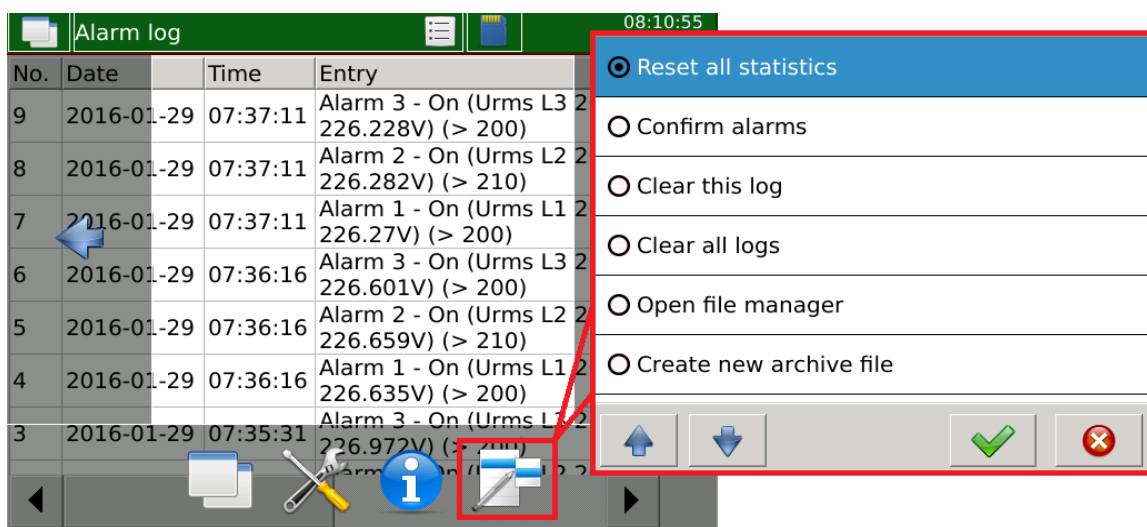

**Fig. 38. Navigation - context menu.**

Function	Description
Reset all statistics	Deletes minimum and maximum values.
Confirm alarms	Opens the window where alarms can be confirmed.
Clear this log	Deletes selected log.
Clear all logs	Deletes all entries in all logs.
Open file manager	Opens the window of file manager.

Authorization is required to perform the described functions. After selection it is necessary to confirm authorization by entering password in the following dialog box.

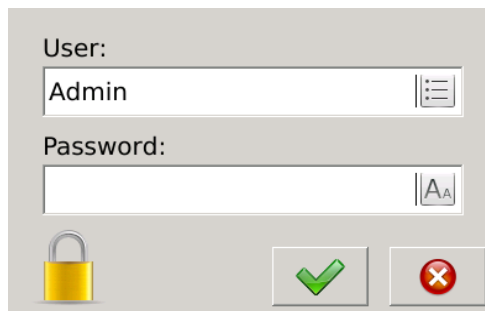

Fig. 39. Navigation - login screen.

## 2.2. Control Panel

Operation of the control panel involves selecting one of the available parameter groups. The individual group allows for full configuration of the device, depending on user requirements.

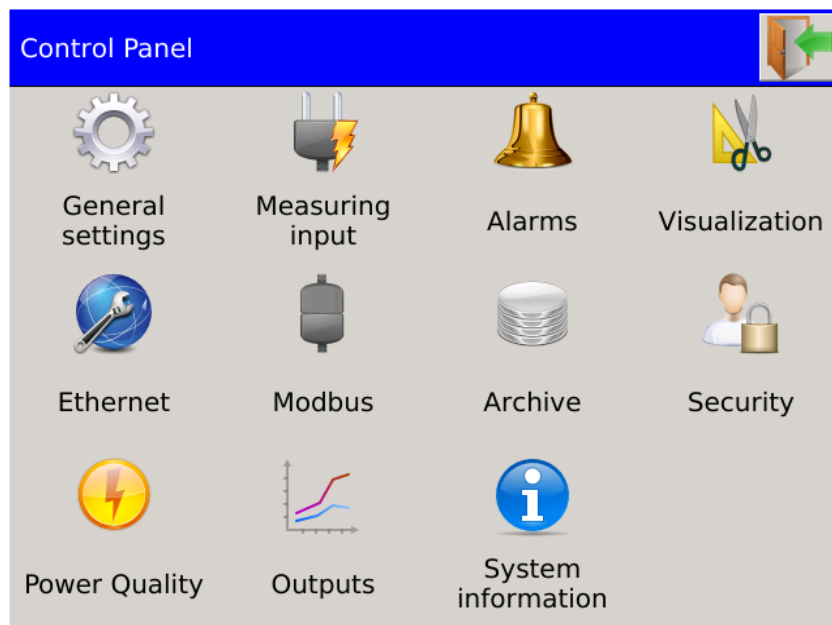



Fig. 40. Control Panel - main screen

### 2.2.1. Navigation

Control Panel is opened with the button located on the main screen 

Configurations are edited by selecting the appropriate option on the main screen of the Control Panel. After pressing the selected icon a dialog box with a set of configuration parameters appears.

The first tab in the individual dialog boxes is opened by default, the other tabs are opened according to the rule set forth below.

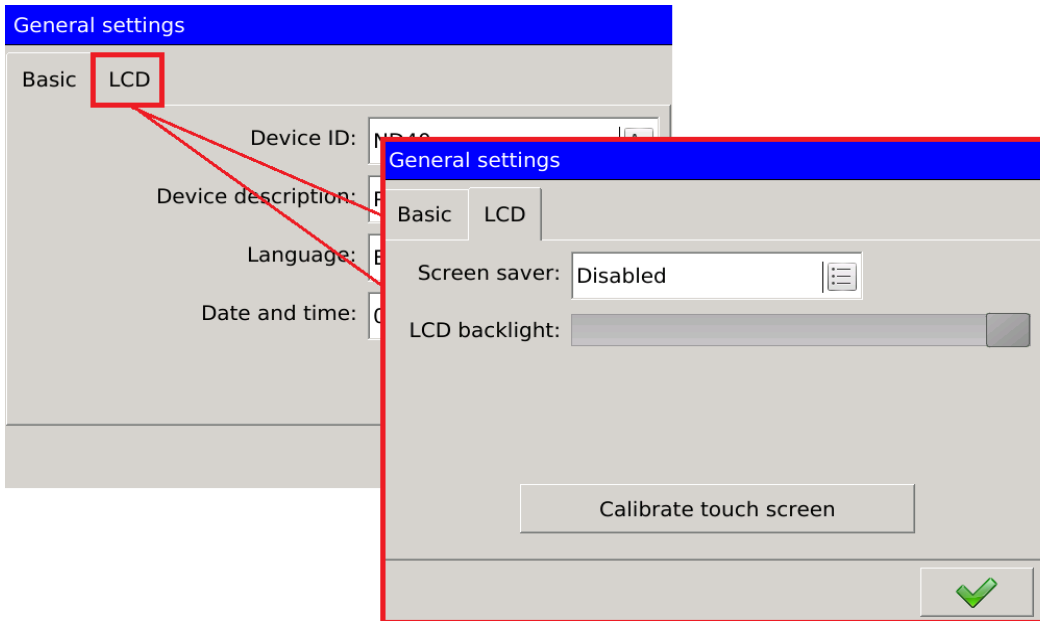

**Fig. 41. Navigation - opening tabs**

Parameter groups such as Alarms or Security have an additional check box to select the parameter to be configured. Navigation between them is done as shown in *Fig. 38*.below. By touching the desired field the selection list of available components is generated.

There are also navigation buttons in the main window with  which it is possible to change the options without opening an additional dialog box.



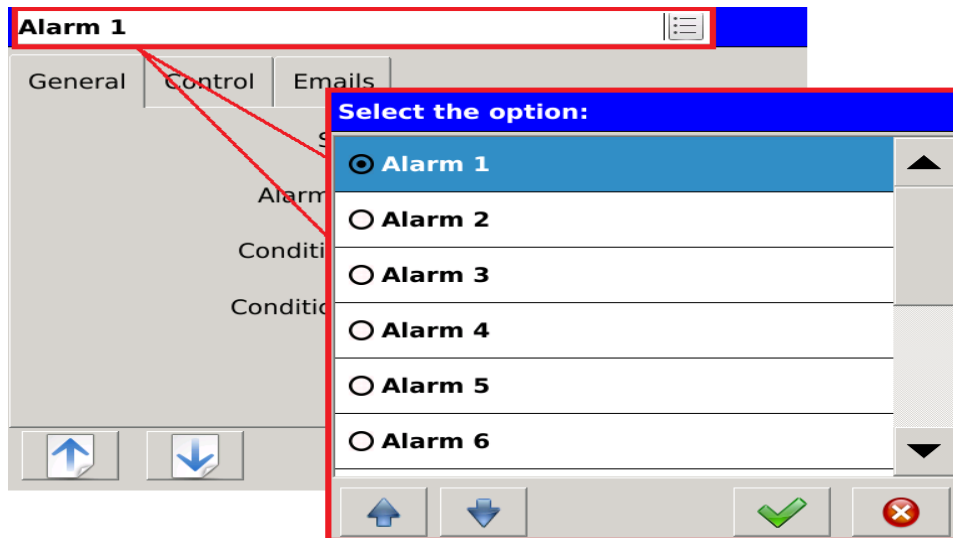

Fig. 42. Navigation - switching configured parameters.

## 2.2.2. Functionality

Access to the Control Panel is secured with the login window protecting from unauthorized access to the device settings. Users are identified by user name and password assigned to the name.

After login the User can choose one of the three options of configuration changes. Selecting the first option *Fig. 43* redirects to the main window of the Control Panel. Selecting the Close button redirects to the main screen of the device.

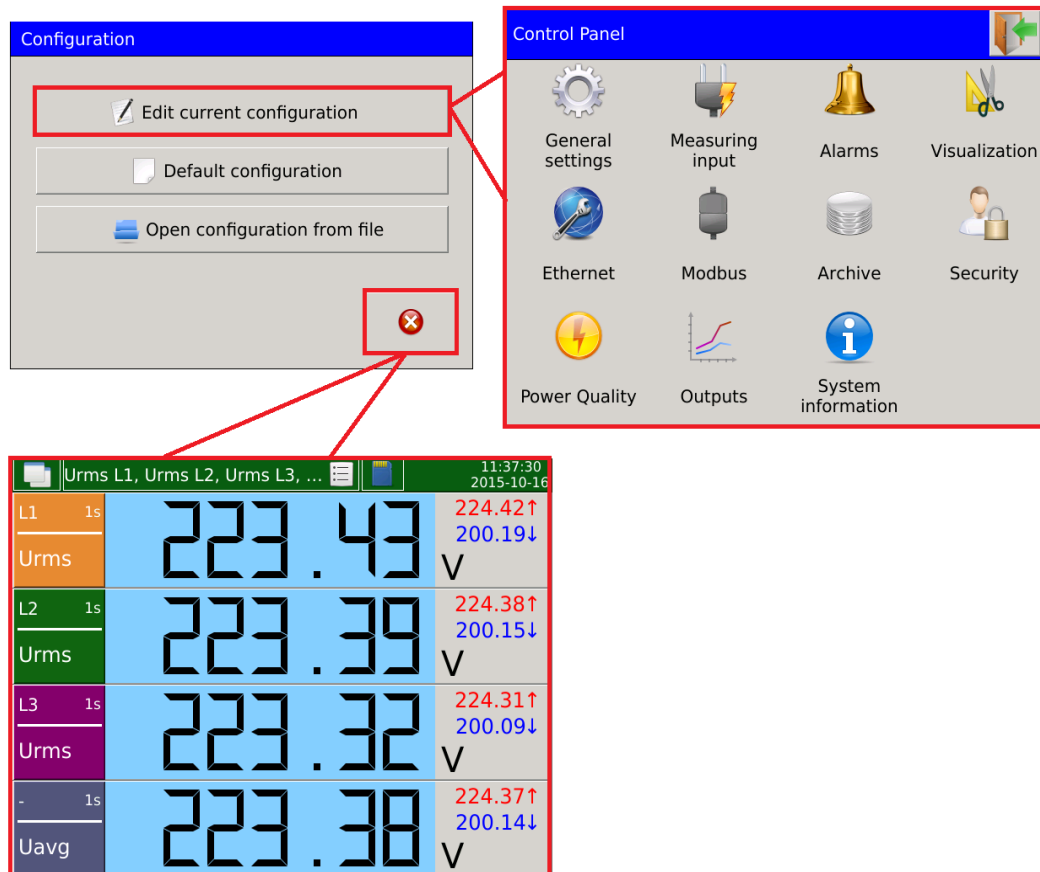

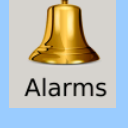









Fig. 43. Navigation - Control Panel.

The individual options of the Control Panel are described in the following list.

Option	Description
 General settings Fig. 44. Option 1.	Selection of the name and ID of the device. Changing the language, setting date and time. Editing parameters of the LCD, such as screen saving, backlight and screen calibration.
 Measuring input Fig. 45. Option 2.	General settings of frequency, connection type, phase synchronization, averaging time. Gear settings, settings of the direction of the current, temperature sensors or resistance measurement.
 Alarms Fig. 46. Option 3.	The settings for the individual alarms, including the source, type and conditions when the alarms turn on / off. Additional options allow for setting the relays, confirmations, delays, switching and alarm logs.

 <p>Visualization</p> <p><b>Fig. 47. Option 4.</b></p>	<p>Settings for screens and trends. The User can turn on or turn off individual screens, select parameters presets or define their own ones that will be displayed on the device. Settings for trends include the selection of parameters sets and the definition of the data presentation field for each set.</p>
 <p>Ethernet</p> <p><b>Fig. 48. Option 5.</b></p>	<p>Settings of DHCP, IP address, subnet mask, default gateway and FTP server.</p>
 <p>Modbus</p> <p><b>Fig. 49. Option 6.</b></p>	<p>Settings of Modbus slave protocol allowing the mode and transmission speed setting. Settings of the device ID and parameters related to TCP Module, switching on/off and port number.</p>
 <p>Archive</p> <p><b>Fig. 50. Option 7.</b></p>	<p>Settings of archiving parameters. General archiving parameters: the number of records in the file, the time range of archiving, conditional archiving. Management of the individual parameters of archiving: parameter selection, specifying the time interval and the condition of archiving.</p>
 <p>Security</p> <p><b>Fig. 51. Option 8.</b></p>	<p>Settings of users rights. Assigning name, password and access rights.</p>
 <p>Power Quality</p> <p><b>Fig. 52. Option 9.</b></p>	<p>Settings of parameters related to recording dips, swells and voltage interrupts.</p>
 <p>Outputs</p> <p><b>Fig. 53. Option 10.</b></p>	<p>Configuration of analog outputs and relays operation. Settings of access depending on the version of the analyzer.</p>
 <p>System information</p> <p><b>Fig. 54. Option 11.</b></p>	<p>General information about the system, memory, hardware, updates and access to the service tab.</p>

### 2.3. Screens and views of data presentation

Visualization of measurement parameters has been divided into screens and groups of views assigned to them. Depending on the configuration settings, the User can choose selected screens for presentation, along with the group of views assigned to them. For example, large digital view is the first element which belongs to the group of screens. The User can assign the selected measured

values that will be available in the subsequent views.

### 2.3.1. Signs and colors of measurement parameters

The example below *Fig.55* shows an example screen (large digital view) with a view containing U RMS values of the individual phases and their average value.

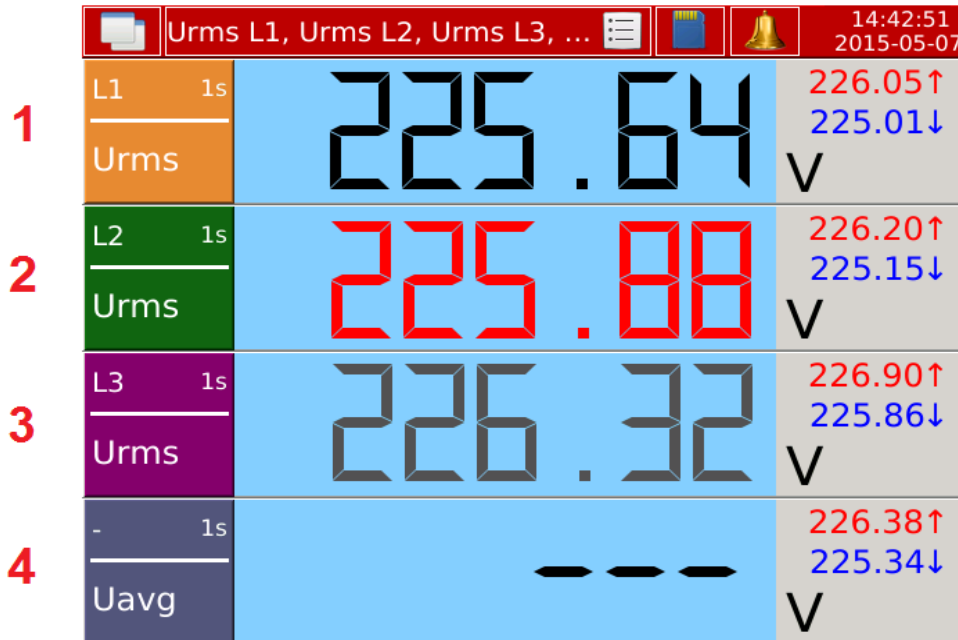

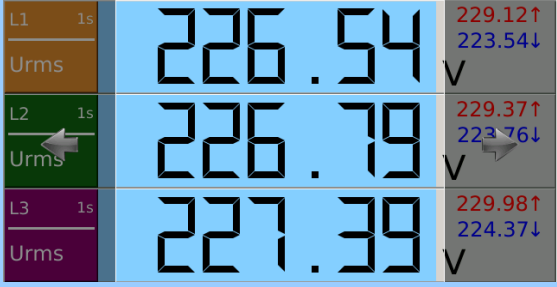
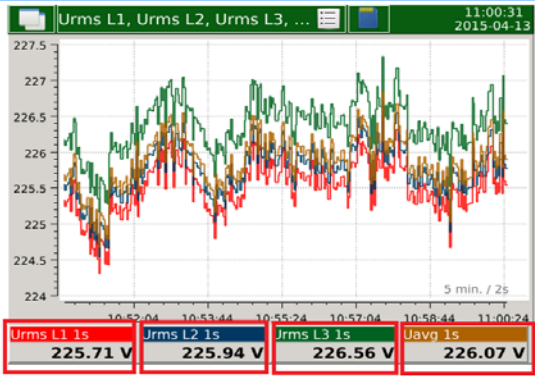
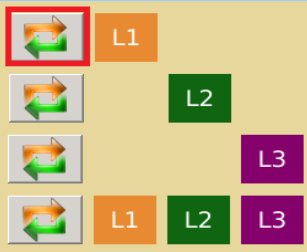

Fig. 55. Presentation of measurement data.

The table below summarizes the various options of the screen from Fig.51 with a description of the basic elements.

Option	Description
1	Example of the correct measured value, which contains all the component measurements necessary for the aggregation of values.
2	Alarm relating to the displayed value.
3	The value was not correctly calculated. The measurement is incomplete for the aggregation.
4	Wrong value or no value.

### 2.3.2. Navigation

The table below shows the set of navigational elements that allow the User to interact with the individual views or screens.

Navigational element	Description
<b>Applies to all screens :</b>	
 <p data-bbox="327 763 566 790">Fig. 56. Navigation 1.</p>	<p data-bbox="750 427 1437 573">Navigation with left / right arrows. It allows the User to switch between the views of individual screens. Navigation arrows are generated by touching the screen of the device.</p>
<b>Trends :</b>	
 <p data-bbox="327 1301 566 1328">Fig. 57. Navigation 2.</p>	<p data-bbox="750 875 1437 1021">Touching selected elements of the presented trends screen, the User can add or remove the selected parameter from the main screen of trends presentation.</p>
<b>Harmonics</b>	
 <p data-bbox="327 1783 566 1809">Fig. 58. Navigation 3.</p>	<p data-bbox="750 1469 1437 1648">Touching the selected element on the screen, the User can change the harmonic elements displayed on the main screen. The device allows the User to generate harmonics for individual phases or a summary of all three phases.</p>
 <p data-bbox="327 1966 566 1993">Rys.59. Navigation 4.</p>	<p data-bbox="750 1839 1437 1984">The presented elements allow the User to increase or decrease the scale of harmonics. The maximum value displayed on the main screen is limited to 100% and the minimum to 2%.</p>

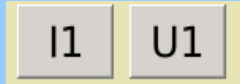

Fig. 60. Navigation 5.



Fig. 61. Navigation 6.

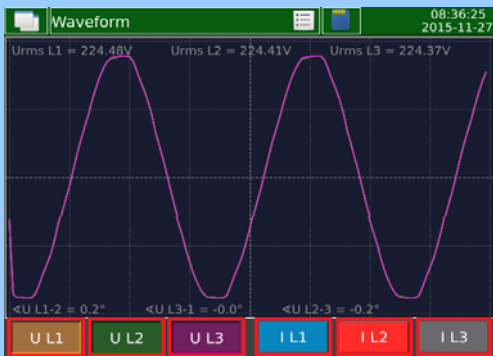

Fig. 62. Navigation 7.

**Vector diagram :**

Scaling the vectors length to I1 or U1.

Selection of the initial axis of the first phase.

**Waveform :**

Touching selected elements of the presented waveform view, the User can add or remove the selected parameter from the screen.

**2.3.3. Functionality**

Each screen has individual features for data presentation. The following sections describe the different types, with a description of the elements available to the User.

### 2.3.3.1. Large digital view

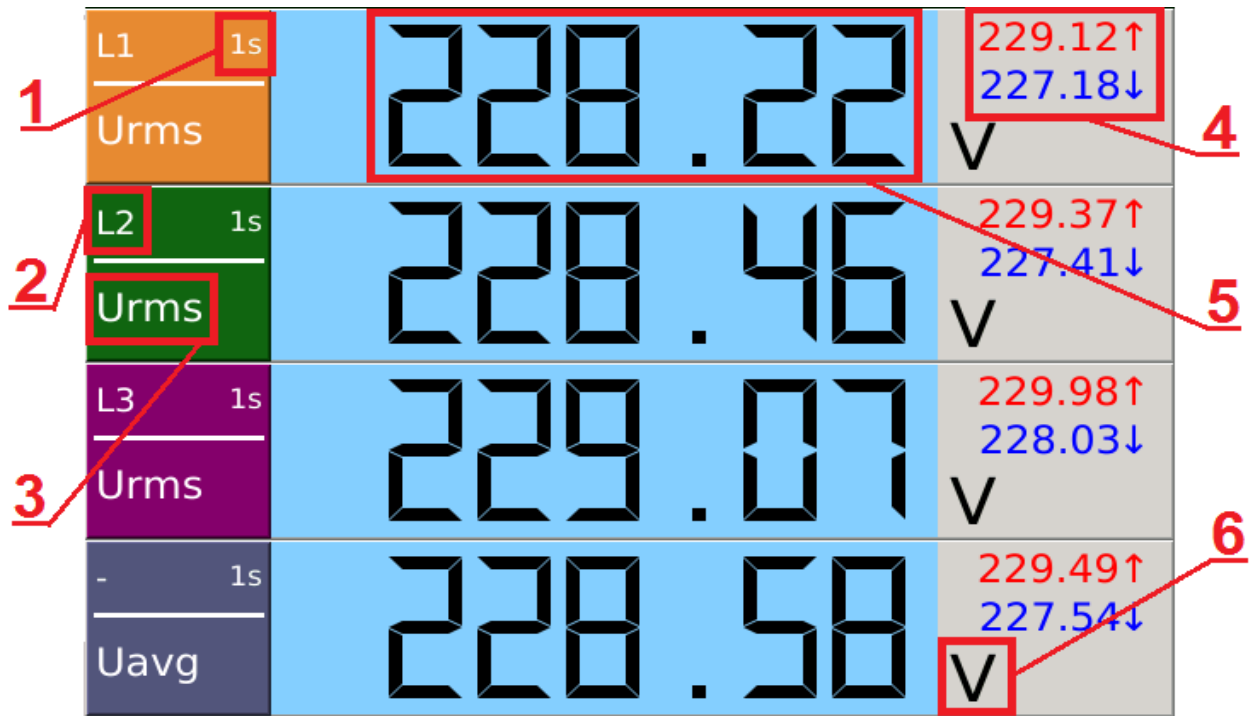

Fig. 63. Large digital view.

Option	Description
1	Aggregation time of the presented value.
2	Additional information describing the phase associated with the presented value.
3	Description of the presented parameter.
4	The minimum and maximum values of the presented value.
5	Main field with the measured value.
6	Unit describing the measured value.

### 2.3.3.2. Analog indicators

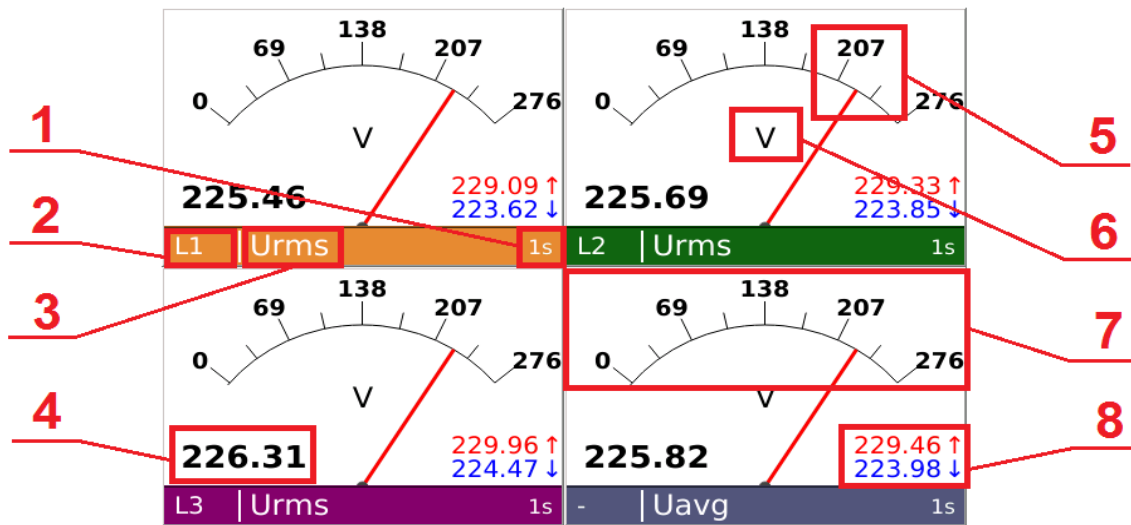

Fig. 64. Analog indicators.

Option	Description
1	Aggregation time of the presented value.
2	Additional information describing the phase associated with the presented value.
3	Description of the presented parameter.
4	Measured value in digital form.
5	Analog indicator presenting the value of the measured parameter.
6	Unit describing the measured value.
7	The scale of the analogue display for the presented measured value.
8	The minimum and maximum values of the presented value.



2.3.3.3. Trends

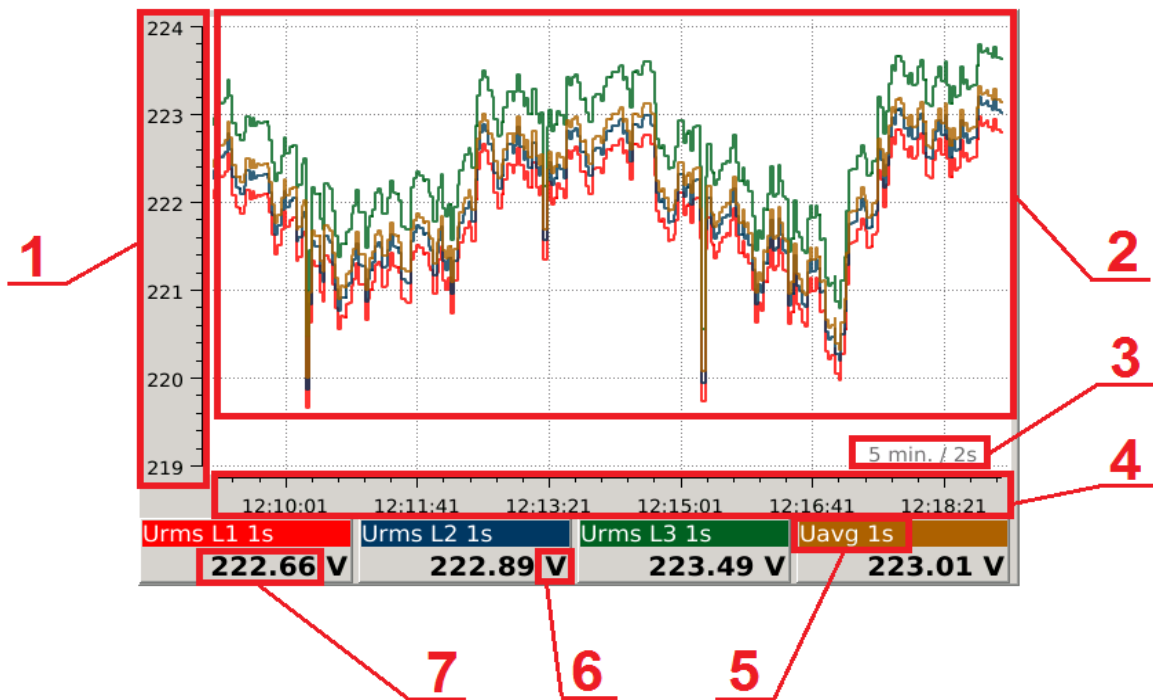

Fig. 65. Trends.

Option	Description
1	The scale describing the range of values in the presented time. The range is scaled automatically together with the changes of the measured values.
2	Main window of trends presentation.
3	The range of time of the values presentation on the trends with the information about the parameters update frequency. For parameters aggregated every 1 second the presented value is the average value of two measurements.
4	Time axis is updated automatically together with the successive measured values presented on the main screen.
5	Description of the measured parameter. The description includes, among others, the parameter name, the information about the phase and the aggregation time.
6	Unit of the selected measured parameter.
7	Value of the measured parameter in digital form.

2.3.3.4. Harmonics and interharmonics

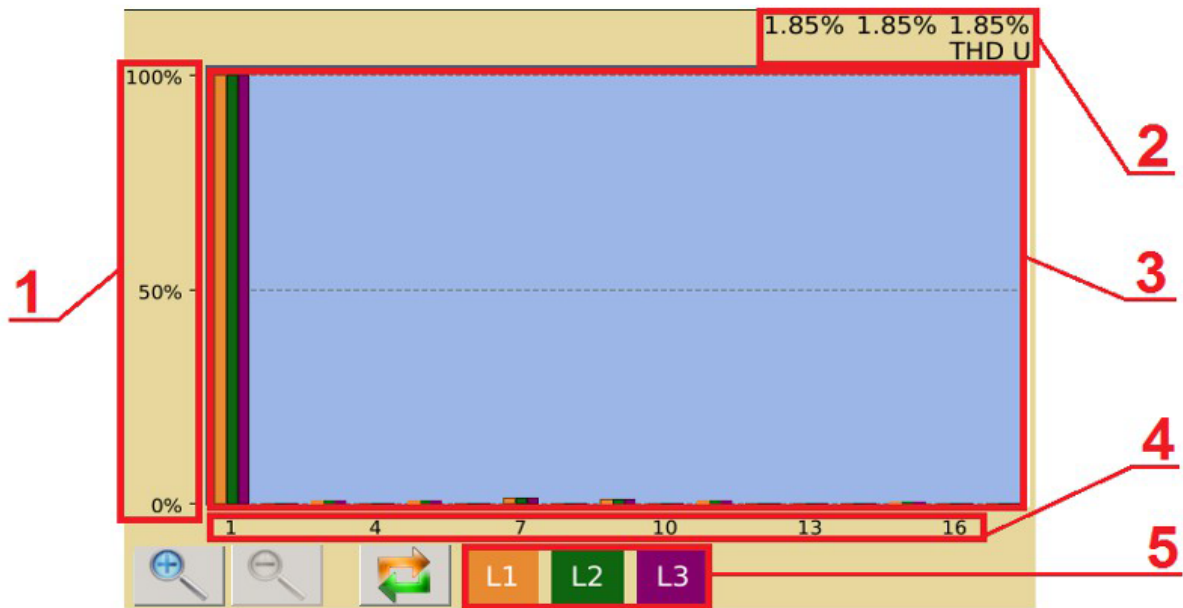

Fig. 66, Harmonics.

Option	Description
1	The scale determining the value of each harmonic, expressed as a percentage.
2	Additional field with information regarding the THD of the selected phases.
3	Main window of harmonics presentation.
4	Values describing the consecutive numbers of the presented harmonics.
5	Colors assigned to the individual phases in accordance with the harmonics presented in the main window.

	L1 [%]	L2 [%]	L3 [%]
THD	2.06	2.07	2.06
THDG	1.92	1.93	1.92
THDS	0.00	0.00	0.00
PWHD	2.06	2.07	2.06
1	100.00	100.00	100.00
2	0.05	0.05	0.05
3	0.66	0.66	0.66
4	0.03	0.02	0.03
5	0.55	0.55	0.55
6	0.03	0.03	0.03
7	1.08	1.08	1.08
8	0.04	0.04	0.04
9	1.13	1.13	1.13

Fig. 67. Harmonics - the table.

Option	Description
1	Fields describing the values presented on the main screen.
2	Description of the subsequent harmonics displayed on the main screen.
3	Division into phases for values presented on the main screen.
4	Main screen containing the values for the individual parameters.

Reading of interharmonic values is possible through modbus registers according to point 12.8.16 and WWW page.

2.3.3.5. Energy

$\Sigma$ EnP+	<b>00013869.2 kWh</b>
L1	00002486.5 kWh
L2	00005382.1 kWh
L3	00006000.6 kWh
$\Sigma$ EnP-	<b>00107844.0 kWh</b>
L1	00008416.3 kWh
L2	00007054.1 kWh
L3	00092373.6 kWh
$\Sigma$ EnQ	<b>00291655.7 kvarh</b>
L1	00094848.1 kvarh
L2	00121046.9 kvarh
L3	00075760.7 kvarh

Fig. 68. Energy.

Option	Description
1	The sum of active energy exported to the three phases. The field also describes the assignment of the subsequent three parameters for a given energy.
2	Lists of energy values for individual phases.
3	Displayed value of the measured energy.
4	Window with the list of the sum of the measured imported active energy, along with the values of the individual phases.
5	Unit assigned to the individual value of the measured energy.

2.3.3.6. Vector diagrams

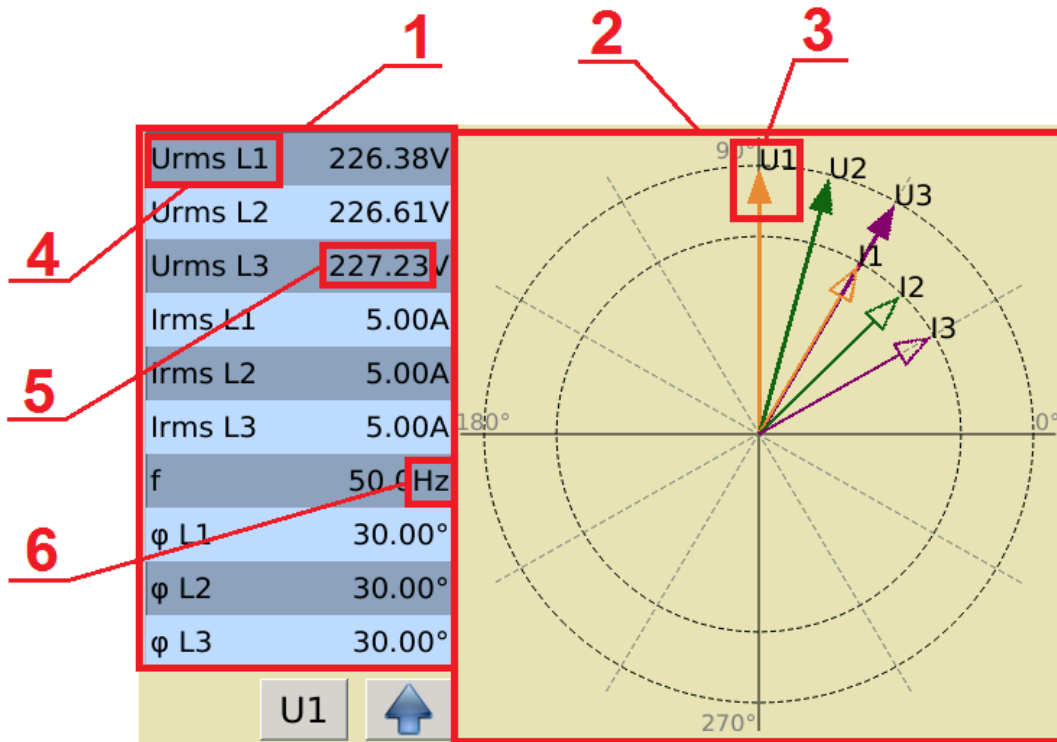

Fig. 69. Vector diagrams.

Option	Description
1	Summary table of values presented in the vector diagram.
2	Main window containing the vector diagram.
3	Measured parameter containing an indication of the angle value and a label with description.
4	Description of the measured parameter with additional information regarding the phase.
5	Value of the measured parameter in digital form.
6	Unit describing the selected measured parameter.

2.3.3.7. Waveform

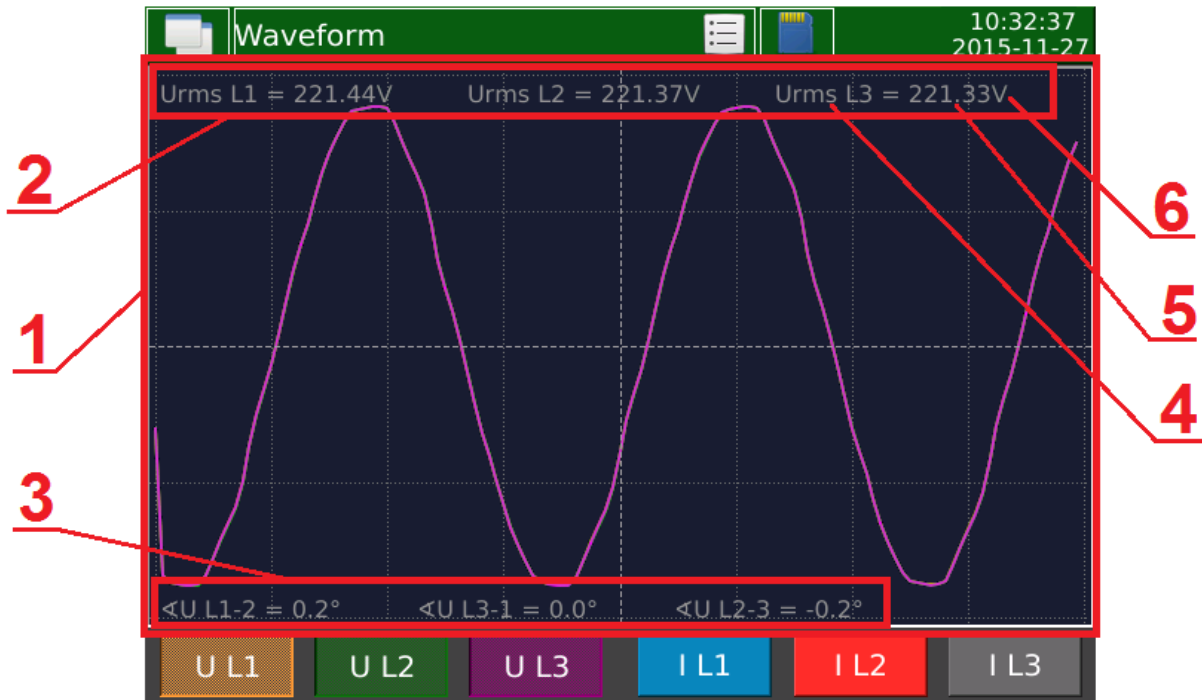

Fig. 70. Waveform.

Option	Description
1	Main window of the waveform screen containing the waveform or waveforms of the selected signals. Other additional information shown in the main window is described in the following paragraphs.
2	Field of presentation of the value of 200ms : Urms L1, Urms L2, Urms L3, Uavg, Irms L1, Irms L2, Irms L3, Iavg – depending on selected signals.
3	Field of presentation of the value of 200ms : $\angle U_{L1-2}$ , $\angle U_{L3-1}$ , $\angle U_{L2-3}$ , $\phi_{L1}$ , $\phi_{L2}$ , $\phi_{L3}$ – depending on selected signals.
4	Symbol of the presented parameter.
5	Value of the presented parameter.
6	Unit of the presented parameter.

2.3.3.8. Temperature / resistance

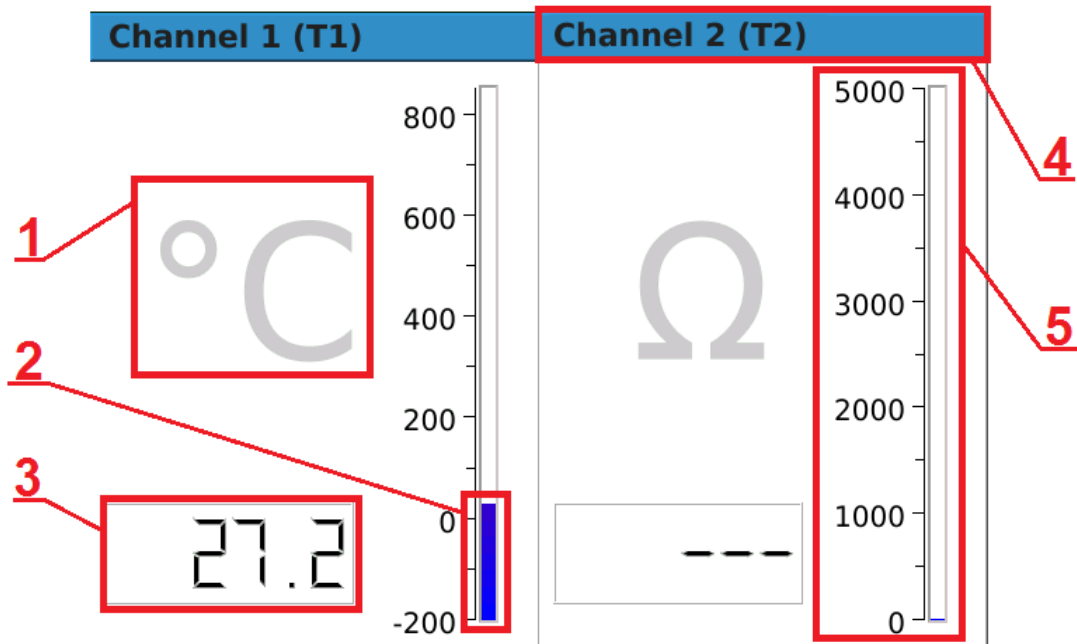

Fig. 71. Temperature / resistance.

Option	Description
1	Description of unit assigned to a given field. Depending on the type of sensor (temperature or resistance)
2	Indicator of the measured value.
3	Measured value in digital form.
4	Description of the channel.
5	Measurement scale, adapted to the type of sensor.

### 2.3.3.9. Binary inputs

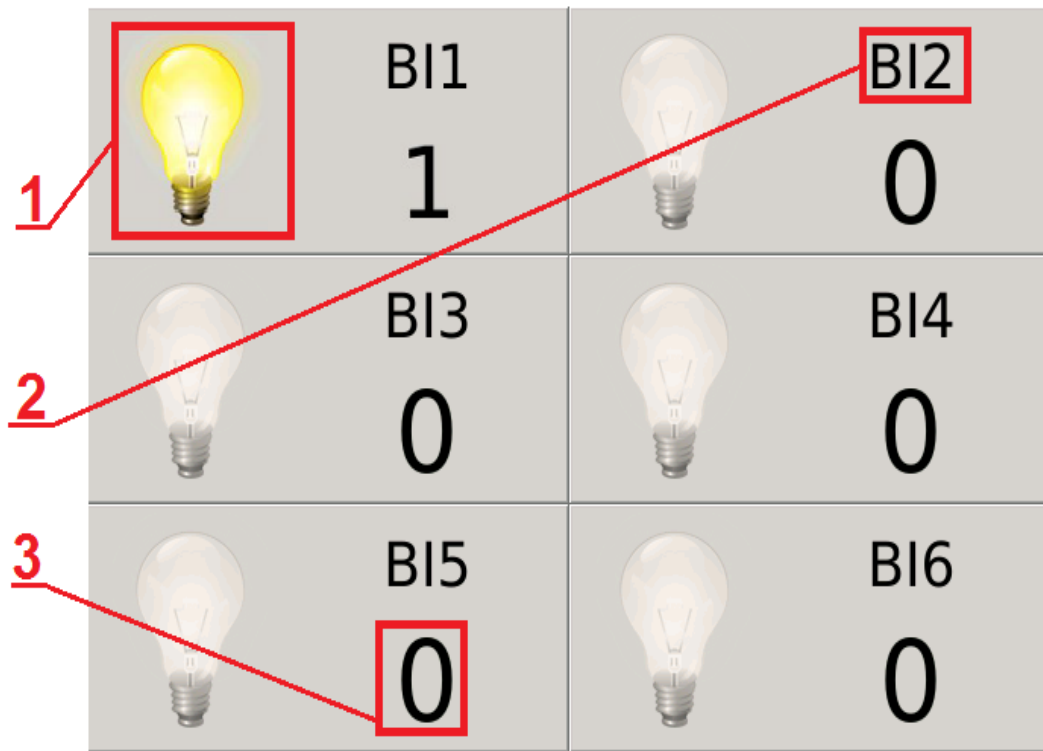

Fig. 72. Binary inputs.

Option	Description
1	Visualization of the state of the binary input: bulb lit - binary input activated, bulb off - binary input deactivated.
2	Status indicator of binary input: 1 – activated, 0 – deactivated.
3	Description of binary output, e.g. : BI2 – binary input number 2.



### 2.3.3.10. Logs

No.	Date	Time	Entry
2	2015-04-15	14:30:21	Configuration changed (Admin)
1	2015-04-15	14:29:26	Configuration changed (Admin)

Fig.73. Logs.

Option	Description
1	The order of the message occurrence.
2	The date of the message occurrence.
3	The time of the message occurrence.
4	The content of the message.
5	An example of a log that contains information about configuration changes.

Audit logs are stored on the SD card. The file containing the current log is saved as **audit.log.csv**. Preview a file stored on the SD card is shown below.

```

1 2016-01-29 07:35:29 Configuration changed (Admin)
2 2016-01-29 07:36:14 Configuration changed (Admin)
3
4
    
```

Fig. 74. Audit logs – save to file.

Each audit log file can contain up to 100 records. When all records are full the next file **audit.log.csv** is created and the previously saved file is changed to **audit.log.1.csv**. When records in the next audit logs are full, subsequent ones are created : **audit.log.2.csv**, **audit.log.3.csv** itd.

**Caution!** Views of Logs screens relating to alarms are described in section 9. *Alarms*.

## 2.4. Software update

To update the software of the ND45 analyzer the update file should be downloaded from the manufacturer's website. The downloaded file must be copied to the SD card of the analyzer.

In the Control Panel, in System Information tab, select the Update group and then select the update file.

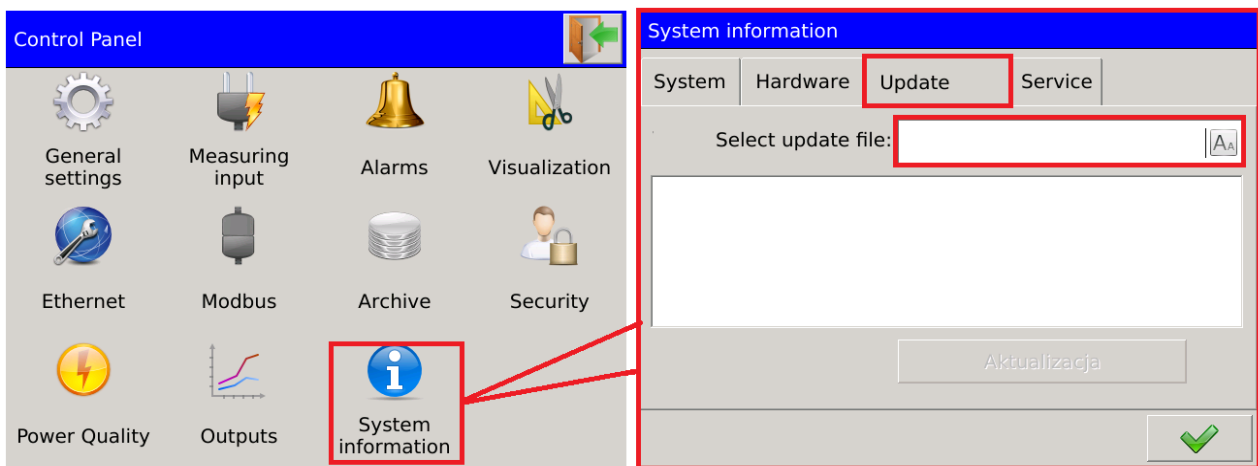

Fig. 75. Selection of update file.

The user confirms the selection from the list of detected files. Information about the update will be displayed in the next window. The process is confirmed by selecting Update.

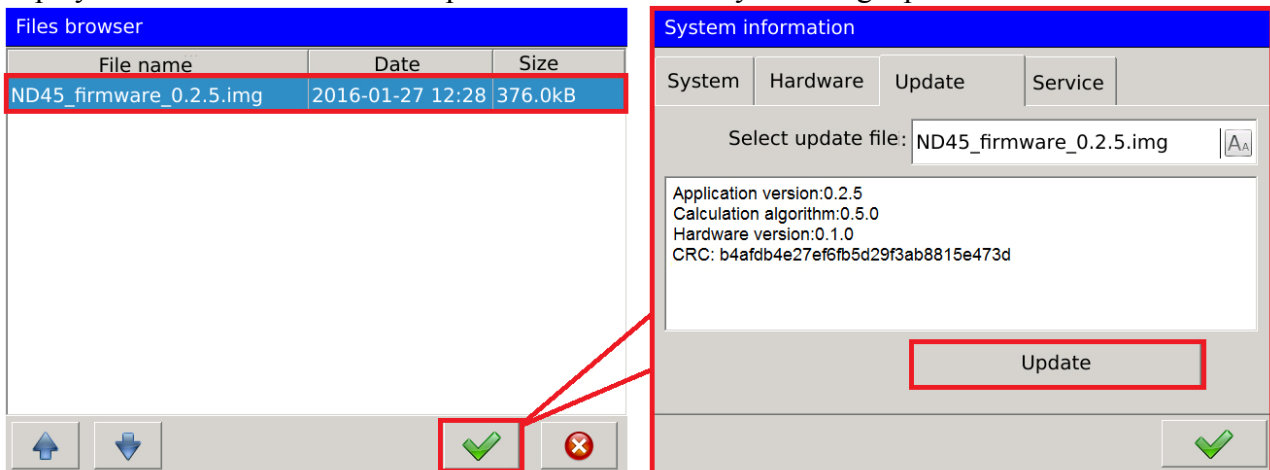

Fig. 76. Update.

### 3. Web server management

Access to the Web server is obtained by entering the IP address assigned to the particular version of the analyzer in the browser.

**Caution!** The IP address of the device can be read by selecting Ethernet option on the Control Panel.

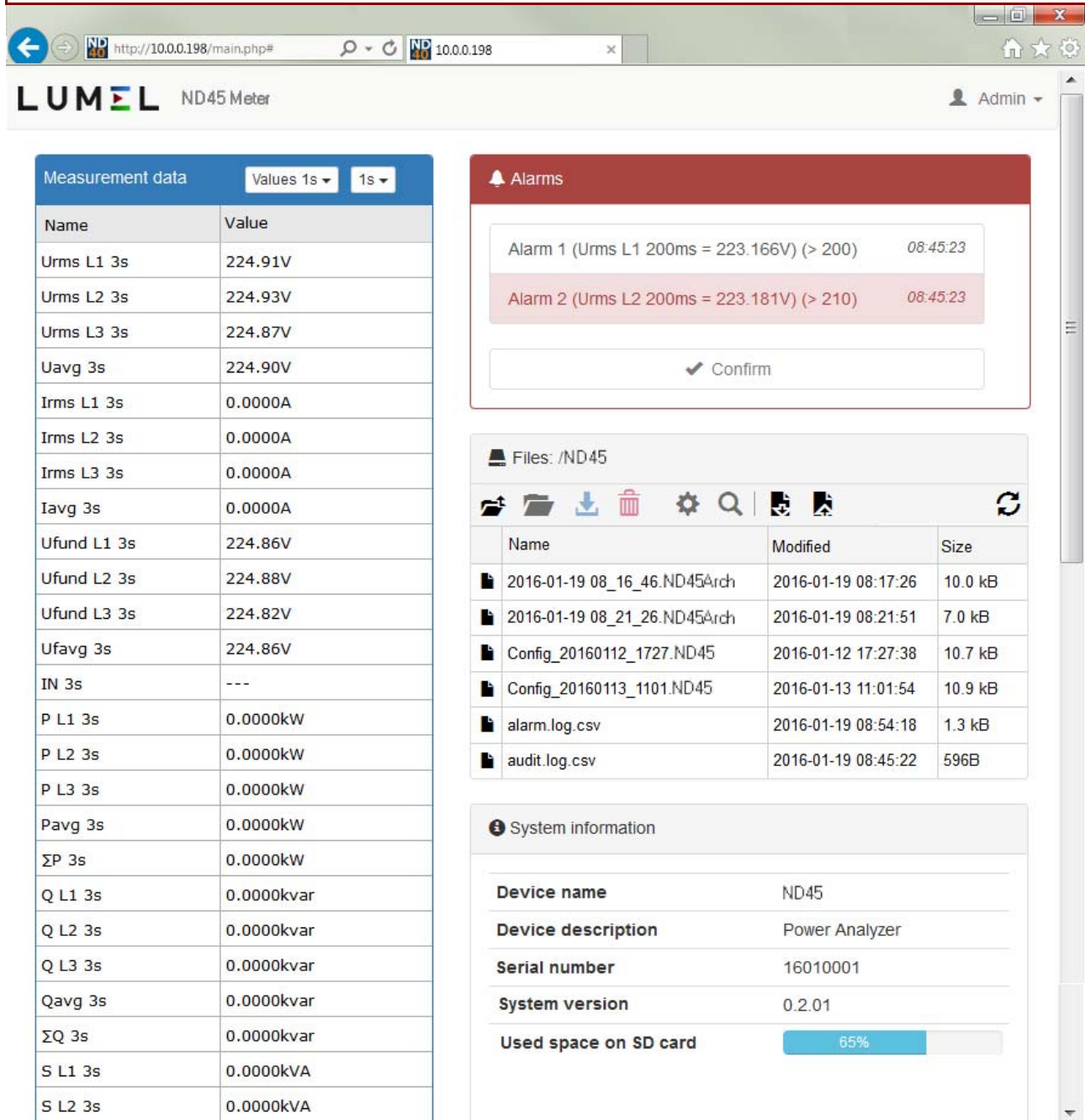
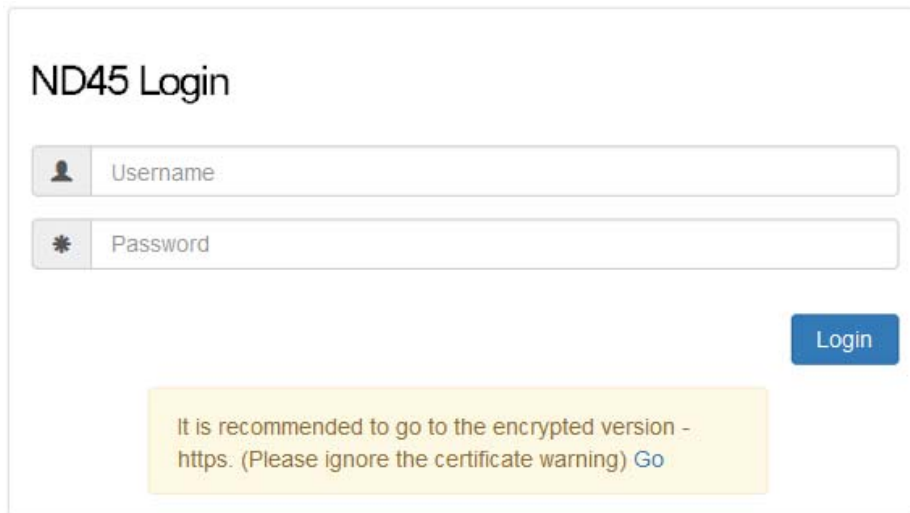

Fig. 77. Web server - general view

### 3.1. Navigation

Depending on the Ethernet configuration settings, two modes of access to the web server are available to the User. The first mode **Users' Access** is preceded by a login window.



ND45 Login

Username

Password

Login

It is recommended to go to the encrypted version -  
https. (Please ignore the certificate warning) [Go](#)

Fig. 78. Web server – login.

According to the message in the login window it is recommended to go to the encrypted page. The login window for the encrypted version is shown below.



ND45 Login

Username

Password

Login

Fig. 79. Web server – encrypted login.

**Anonymous access** automatically redirects to the website with limited functionality.

The table lists the modules presented on the website.

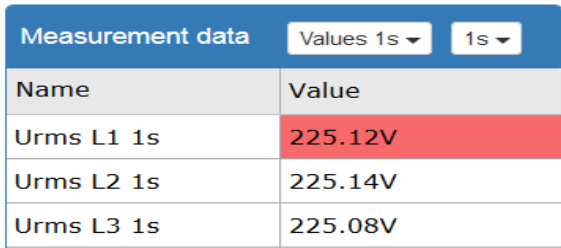
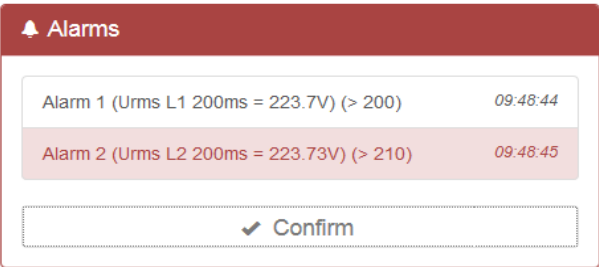
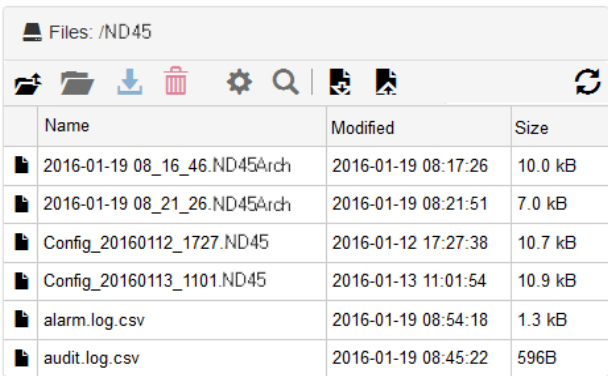
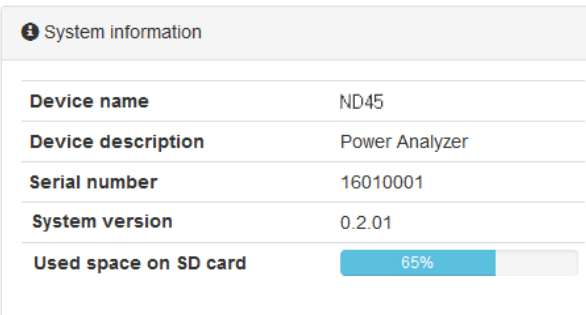
Module	Description
 <p><b>Fig. 80. Web server - module 1.</b></p>	<p>Measurement data. Presentation of current measurements results with an adjustable refresh time.</p> <p>Measurement sets can be individually configured (only in authorized access mode), or presented in the previously defined sets. The values associated with the occurrence of an alarm (not confirmed) change the color of the background.</p>
 <p><b>Fig. 81. Web server - module 2.</b></p>	<p>Alarm module. It presents the current state of the alarms, in the authorized access mode the confirmation of alarms is possible.</p> <p>The module contains information about the number of the alarm, the parameter assigned to the alarm, the value initiating the alarm, the time of the alarm occurrence and the condition of activation.</p>
 <p><b>Fig. 82. Web server - module 3.</b></p>	<p>Module of log files management, configuration and archiving. Edit and preview of the module can only made in the authorized access mode.</p> <p>Each file is described by name, date of modification and size.</p>
 <p><b>Fig. 83. Web server - module 4.</b></p>	<p>Information module, contains basic information about the system.</p>

## 3.2. Functionality

No.	Option	Users' access		Anonymous access
General				
1	Login / Logout	v		x
2	Reboot device	v		x
3	Configuration of the User measurement data sets.	v		x
Measurement data				
4	Preview of measurement data.	v		v
5	Selection of defined sets	v		v
6	Selection of User sets	v		x
7	Change of measurement data refresh time	v		v
8	Disabling the measurement data refresh	v		v
Alarms				
9	Preview of alarms	v		v
10	Confirmation of alarms*	v	x	x
Files				
11	Preview of files*	v	x	x
12	File list refresh*	v	x	x
13	Opening and closing directories*	v	x	x
14	Downloading files*	v	x	x
15	Deleting files*	v	x	x
16	Setting configuration from a file*	v	x	x
17	Preview of archive file*	v	x	x
System information				
18	Preview of system information	v		v

\* function availability depends on the user's authorization settings (5.9. Configuration of safety rules).

### 3.2.1 Login / Logout

Login window is shown in section 3.1. Navigation. Login and password are consistent with access rights defined in the device in the Security tab (section: 5.9 Configuration of safety rules).

The option to log off from the server is located in the upper right corner of the browser. After the selection of the currently logged on user, select **Logout** from the drop-down list.

### 3.2.2 Reboot device

Remote reboot device via the website can be performed as shown below.

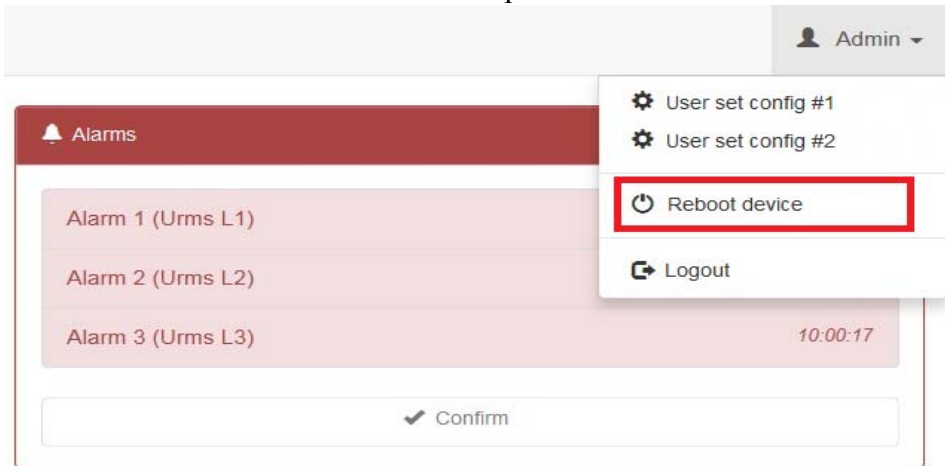

Fig. 84. Web server – reboot.

After the selection of the currently logged on user, select **Reboot device** from the drop-down list. ND45 reboot is confirmed in the next window.

### 3.2.3 Configuration of the User measurement data sets

Defining the sets of the measurement data may be performed as described below.

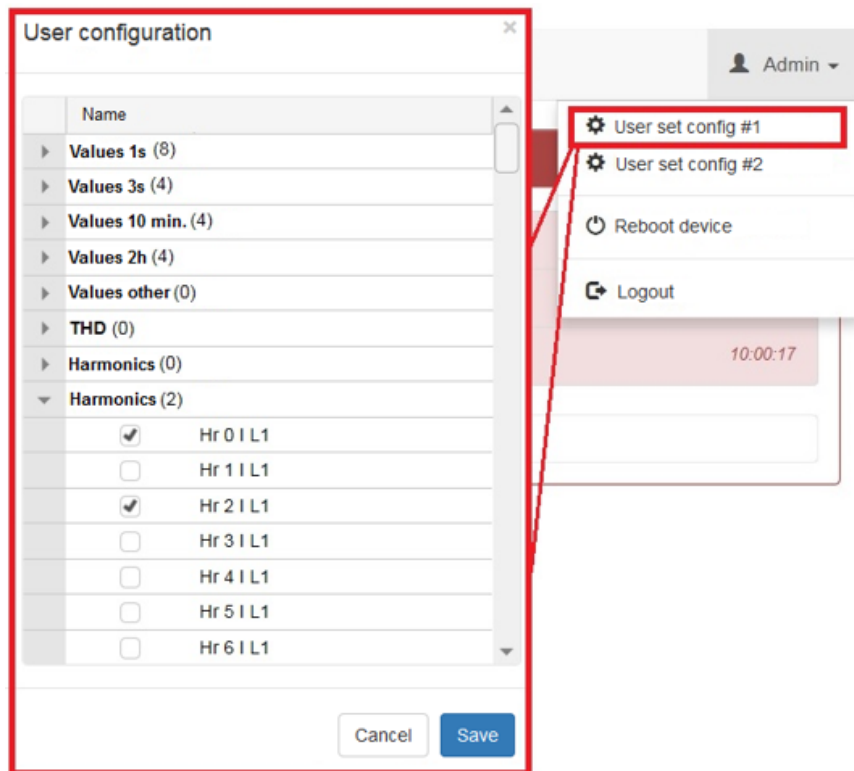

Fig. 85. Web server - User sets

After the selection of the currently logged on user, select **User set config** from the drop-down list.

In the next window, select the data to be presented in the measurement data window. The User selects a parameters group in which, after opening the drop-down list the parameters can be elected or deselected. After the setup is complete, select **Save** (to save the changes), or **Cancel** (closes the window without making any changes).

### 3.2.4 Preview of measurement data

View of a sample window with Measurement Data module is presented in section 3. *Web server management*, the module is described in section 3.1 *Navigation*.

### 3.2.5 Selection of defined sets

An example of changes in the measurement data selected from the default data sets is presented below. The User chooses the option that describes the currently presented data set and then selects one of the suggested sets from the list.



Measurement data		Values 1s	1s
Name		Values 1s	
Urms L1 1s		Values 3s	
Urms L2 1s		Values 10 min.	
Urms L3 1s		Values 2h	
Uavg 1s		Values other	
Irms L1 1s		THD	
Irms L2 1s		Harmonics U	
Irms L3 1s		Harmonics I	
Iavg 1s		Energy meters	
IN 1s		Binary inputs	
P L1 1s		User set #1	
P L2 1s	0.00kW	User set #2	
P L3 1s	0.00kW		
Pavg 1s	0.00kW		

Fig. 86. Web server - displaying the contents.

### 3.2.6 Selection of User sets

An example of changes in the measurement data selected from the individually defined data sets is presented below. The User chooses the option that describes the currently presented data set and then selects one of the suggested sets from the list.

Measurement data		Values 1s	1s
Name		Values 1s	
Urms L1 1s		Values 3s	
Urms L2 1s		Values 10 min.	
Urms L3 1s		Values 2h	
Uavg 1s		Values other	
Irms L1 1s		THD	
Irms L2 1s		Harmonics U	
Irms L3 1s		Harmonics I	
Iavg 1s		Energy meters	
IN 1s		Binary inputs	
P L1 1s		User set #1	
P L2 1s	0.00kW	User set #2	
P L3 1s	0.00kW		
Pavg 1s	0.00kW		

Fig. 87. Web server - selection of User sets

### 3.2.7 Change of measurement data refresh time

Changing the refresh time allows the User to adjust the update frequency of the measurement data displayed on the page.

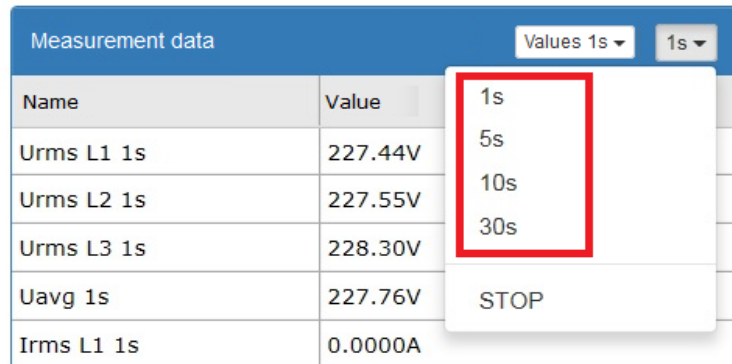

Name	Value
Urms L1 1s	227.44V
Urms L2 1s	227.55V
Urms L3 1s	228.30V
Uavg 1s	227.76V
Irms L1 1s	0.0000A

Fig. 88. Web server - change of refresh interval.

### 3.2.8 Disabling the measurement data refresh

Disabling refresh stops downloading of measurement data from the device and keeps the values displayed at the time of refresh stop.

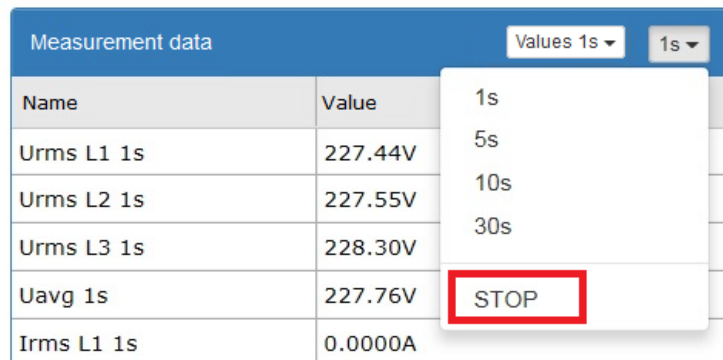

Name	Value
Urms L1 1s	227.44V
Urms L2 1s	227.55V
Urms L3 1s	228.30V
Uavg 1s	227.76V
Irms L1 1s	0.0000A

Fig. 89. Web server - disabling refresh of the measured values.

### 3.2.9 Preview of alarms

View of a sample window with Alarms module is presented in section 3. *Web server management*, the module is described in section 3.1 *Navigation*.

### 3.2.10 Confirmation of alarms

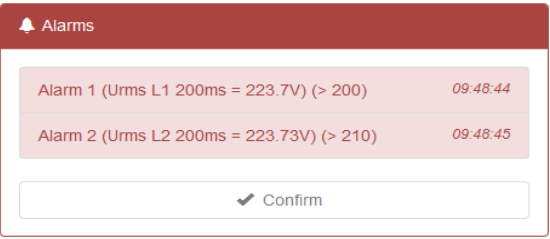
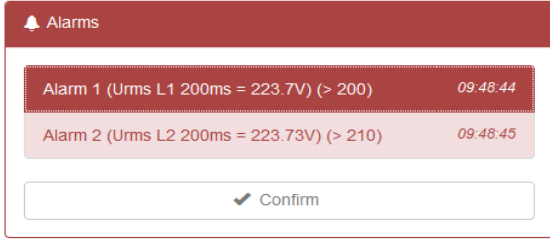
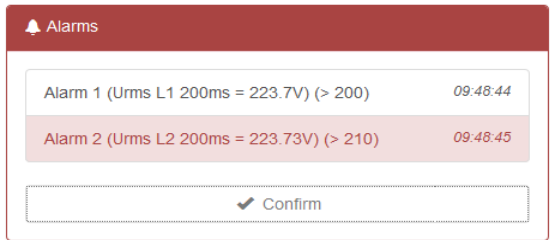
 <p><b>Fig. 90. Web server - alarm 1.</b></p>	<p>The window of alarms module with information about alarms occurrence.</p>
 <p><b>Fig. 91. Web server - alarm 2.</b></p>	<p>The User selects the alarm to be confirmed and confirms the selection pressing <b>Confirm</b>.</p>
 <p><b>Fig. 92. Web server - alarm 3.</b></p>	<p>View of alarms module after alarm confirmation : Alarm 1 (Urms L1 200ms = 223.7V) (&gt; 200) time 09:48:44</p>

### 3.2.11 Preview of files

View of a sample window with Files module is presented in section 3. *Web server management*, the module is described in section 3.1 *Navigation*.

Sample files are stored on SD card.

Function	Sample file	Description
Archive	2016-01-19 08_16_46.ND45Arch	Archive file with the option of preview and export to csv. Format compatible with SQLite.
Configuration	Config_20160112_1727.ND45	The configuration file allows the User to set the configuration from the file on the device.
Alarm logs	alarm.log.csv	Information about alarms occurrence.
System logs	audit.log.csv	Information about system events.
Dips and swells	dipswell.log.csv	Information about the event occurrence.

Dips and swells measurements	dipswellsamples.log.csv	Information with additional measurements preceding and occurring immediately after the event.
Update	ND45_firmware_0.2.5.img	Update file

### 3.2.12 File list refresh

The element of the file management module with which the User can update the list of available files is selected below.

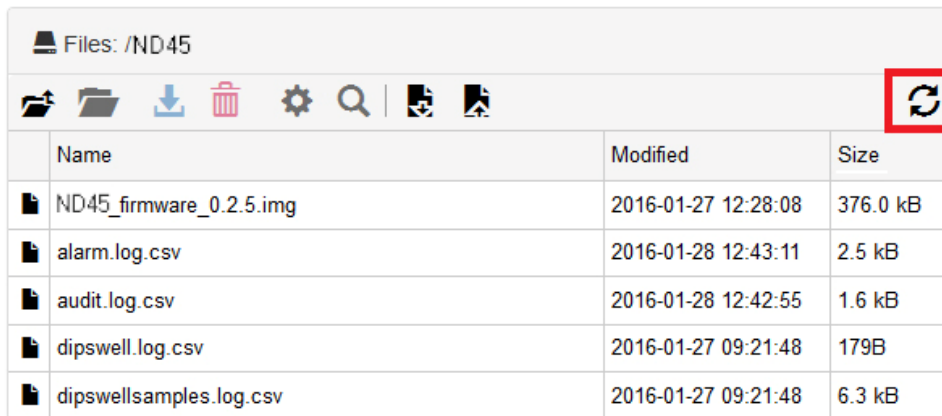

Fig. 93. Web server - files refresh

### 3.2.13 Opening and closing directories

The element of the file management module with which the User can open or close the available directories is selected below.

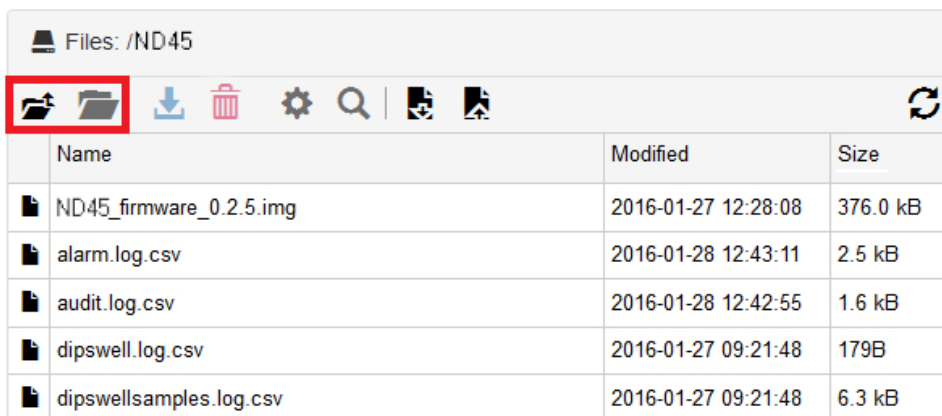

Fig. 94. Web server - opening and closing directories.

### 3.2.14 Downloading files

The element of the file management module with which the User can download the available files is selected below.

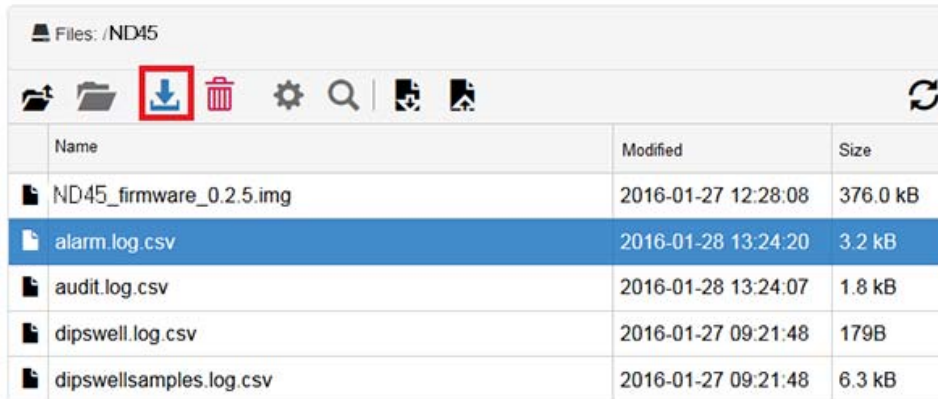

Fig. 95. Web server - downloading files.

### 3.2.15 Deleting files

The element of the file management module with which the User can delete the available files is selected below.

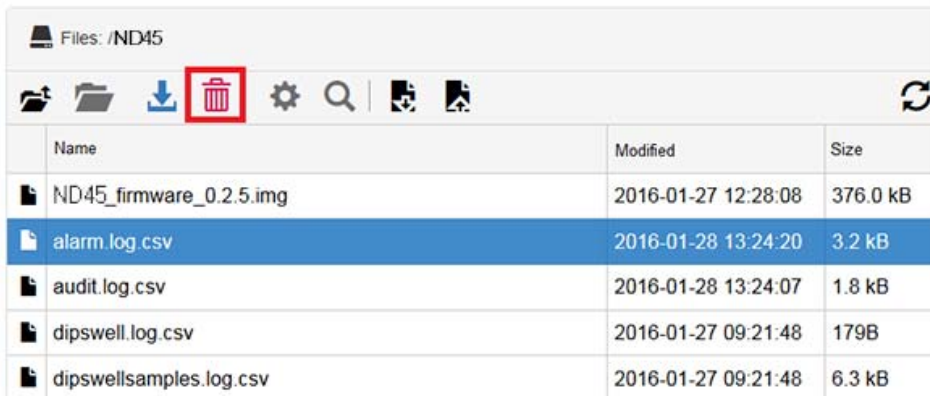

Fig. 96. Web server - deleting files.

### 3.2.16 Setting configuration from a file

The element of the file management module with which the User can set the ND45 configuration from a file is selected below.

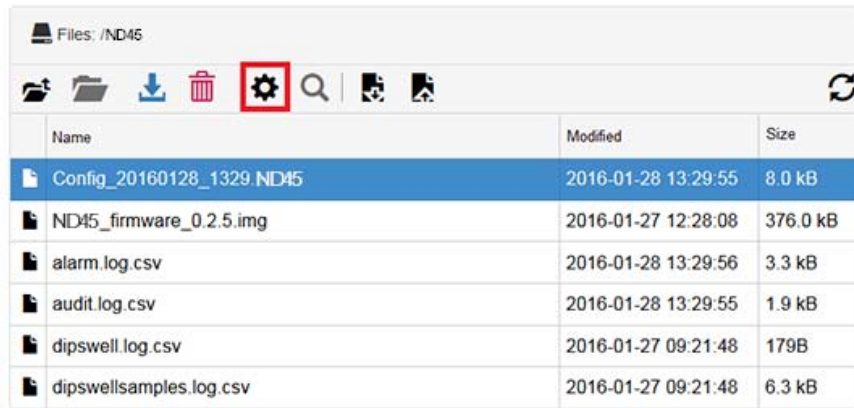

Fig. 97. Web server - loading configuration from a file.

### 3.2.17 Displaying the file contents

The element of the file management module with which the User can preview the available files is selected below.

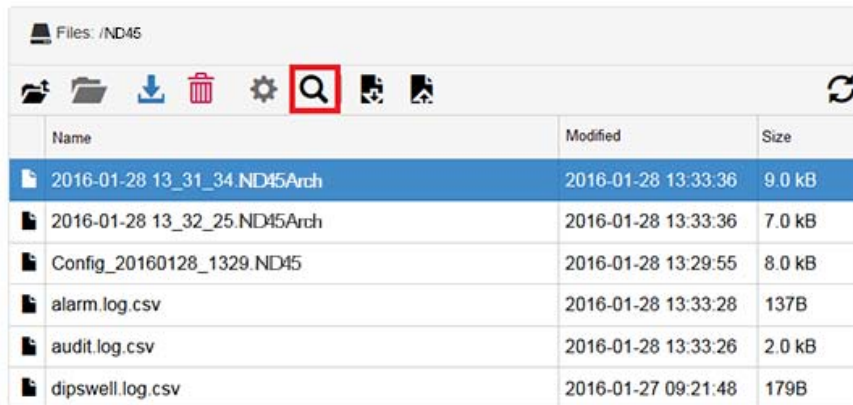

Fig. 98. Web server - preview of file contents.

### 3.2.18 Downloading the current configuration

The element of the file management module with which the User can download the current configuration of the analyzer is selected below.

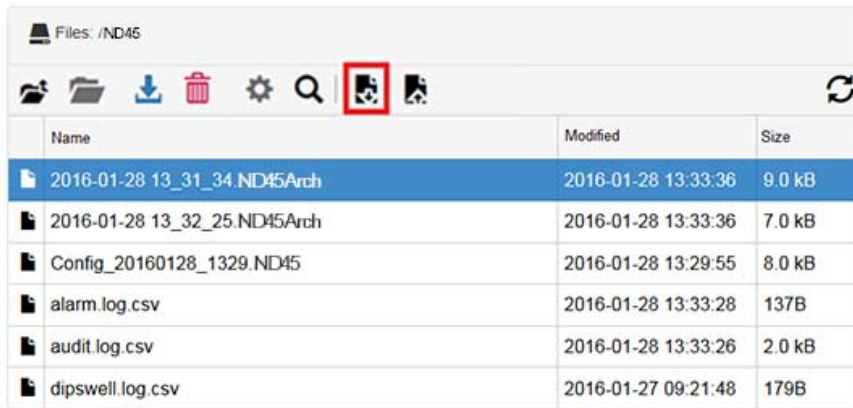

Fig. 99. Web server - loading configuration from a file.

### 3.2.19 Sending a file

The element of the file management module with which the User can send files to the memory card is selected below.

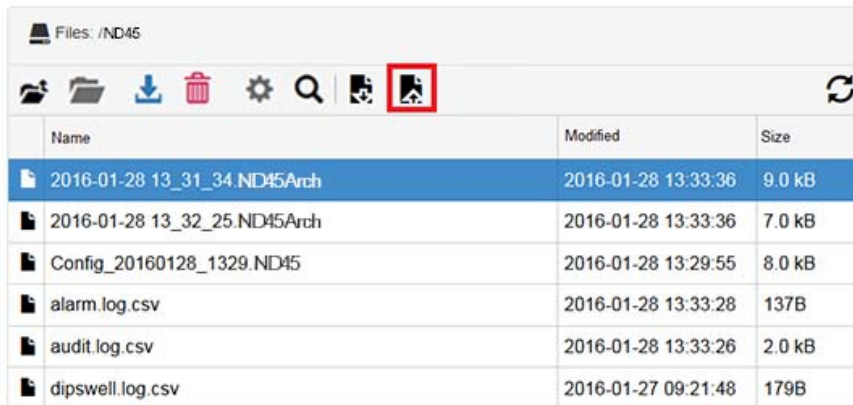

Fig. 100. Web server - sending a file.

### 3.2.20 Preview of archive files

Using the option described in section 3.2.17 (View file content) the User can preview the saved archive files.

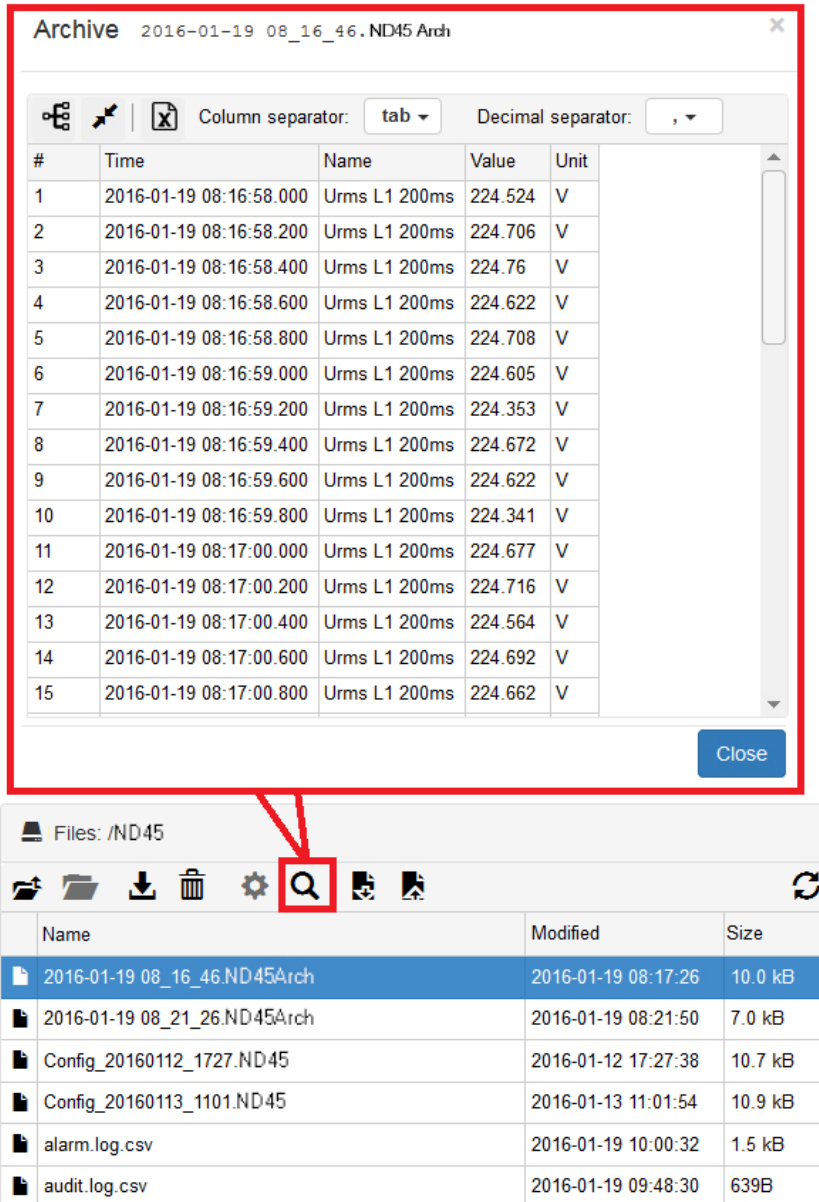

Fig. 101. Web server - preview of archive file.



A sample archive file with the description of tools for presenting and editing is shown below.

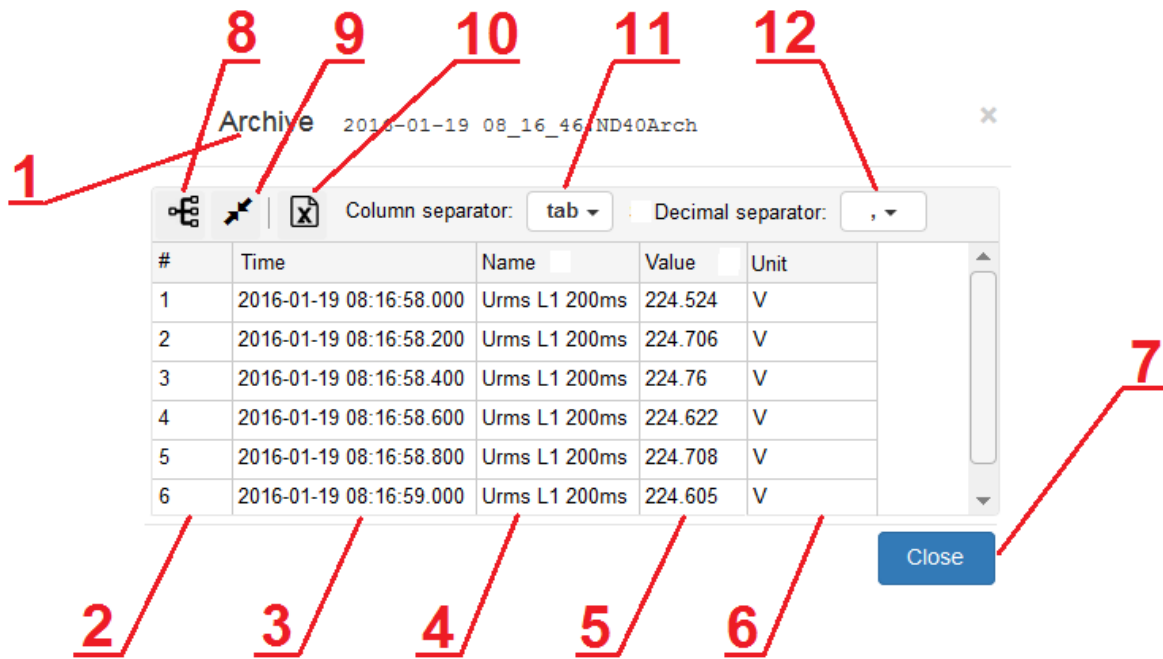

Fig. 102. Web server - properties of archive file.

Option	Description
1	The name of the previewed archive file.
2	The column with the consecutive numbering of the entries in the archive.
3	The column with archiving date and time.
4	The column with the description of the archived parameter.
5	The column with the archived value.
6	The column with the unit of the archived value.
7	The button to exit the archive file preview.
8	The option of grouping according to archiving time.
9	The option of automatic adjustment of the columns width.
10	The option to save the archive file in csv. format.
11	The option to select the columns separator.
12	The option to select the decimal separator.

### 3.2.21 Preview of system information

View of a sample window with System Information module is presented in section 3. *Web server management*, the module is described in section 3.1 *Navigation*.

## 4. FTP server management

### 4.1. Navigation

Switching to the FTP server is possible, for example, by means of the browser window. By using the IP address assigned to the analyzer and entering the FTP access settings into Ethernet tab.



Fig. 103. FTP server.

If the User uses the Users' access (recommended) he/she will be redirected to the login screen. After proper verification of the login and password, the User will be redirected to the stored files.



Fig. 104. FTP server - files.

## 5. Configuration of the device parameters

### 5.1. Configuration management

After login the User can choose one of the three options of configuration changes :

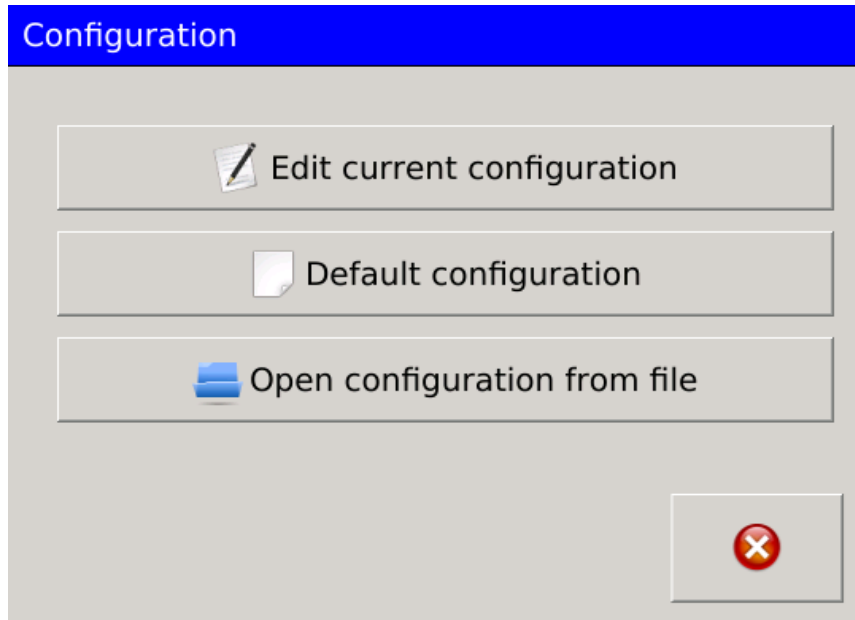
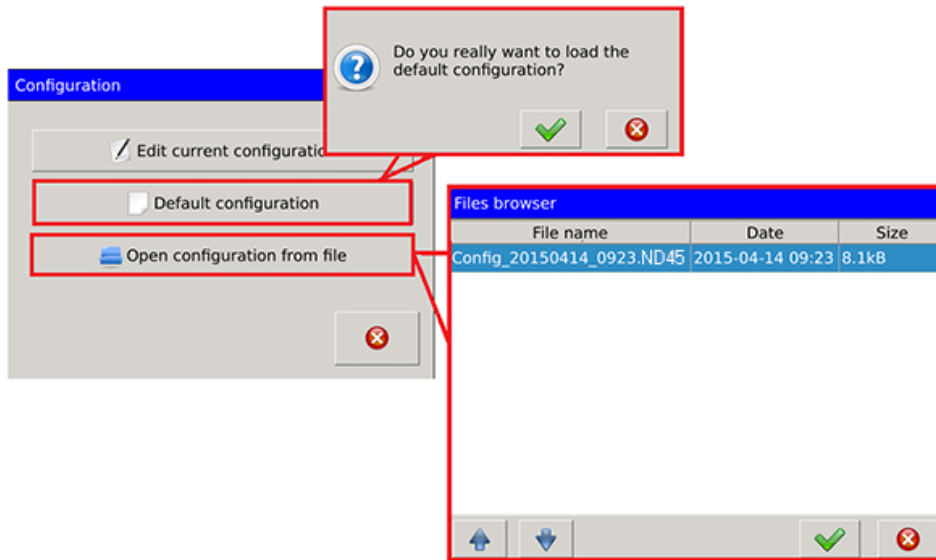

Fig. 105. Configuration.

Option	Description
Edit current configuration	Switching to the Control Panel.
Default configuration	Restores the default configuration for the device.
Open configuration from file	Launches the file browser with a choice of available configuration files.



**Fig. 106. Configuration - default configuration.**

Default configuration settings are preceded by a dialog box requiring confirmation by the User.

File Browser shows the available configuration files possible to be opened and set in ND45. File Browser window contains:

Option	Description
File name	Individual name defined by the User when saving.
Date	Restores the default configuration for the device.
Size	The amount of memory used by the file.

Closing the Control Panel window is shown below. After one option is selected, a dialog box appears to confirm the completion of the configuration edition.

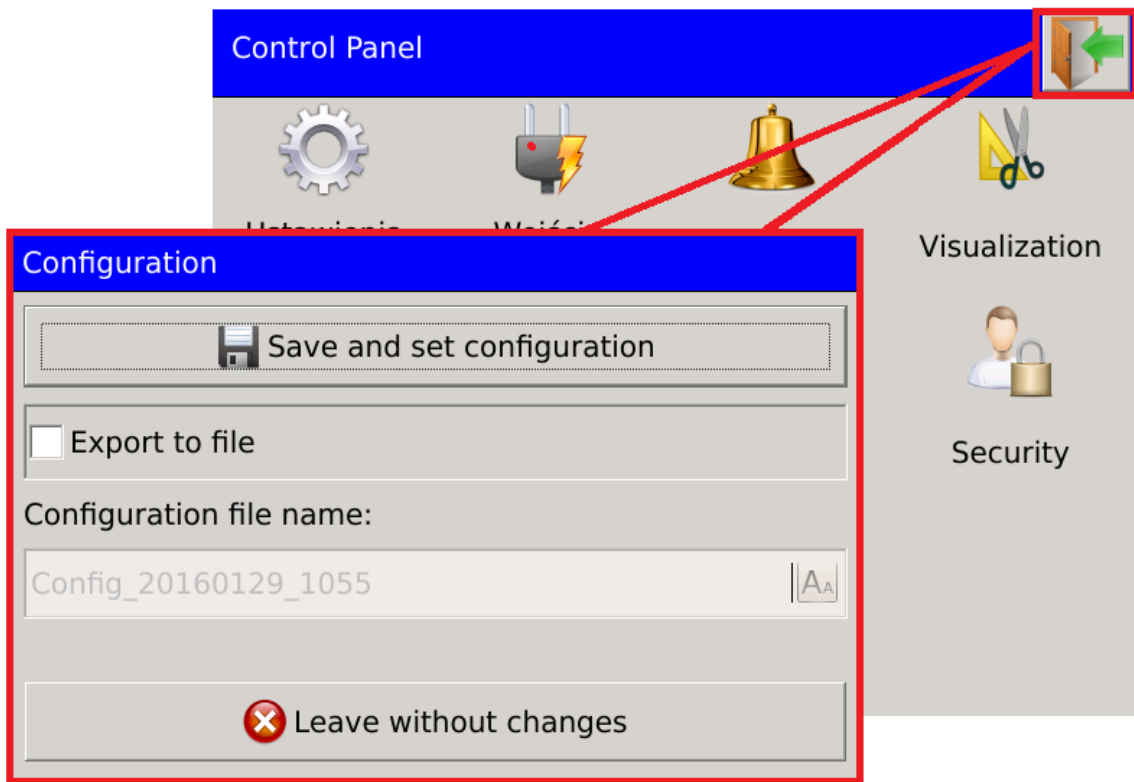

Fig. 107. Configuration - saving.

To save the configuration settings to a file, select the option as shown below. Selecting a field with the name of the file, the User can change the name of the file that normally contains the name describing the file to be saved and the date and time.

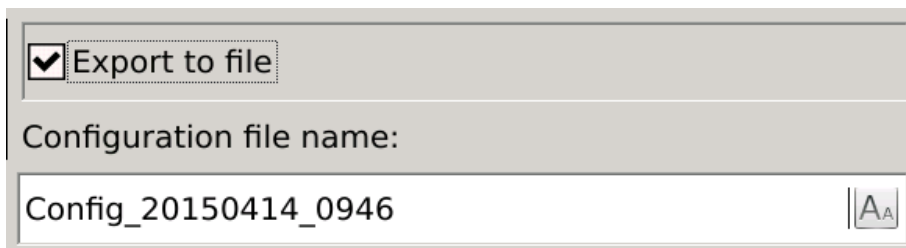

Fig. 108. Configuration - saving to file.

## 5.2. Configuration of general settings

### 5.2.1. Basic parameters

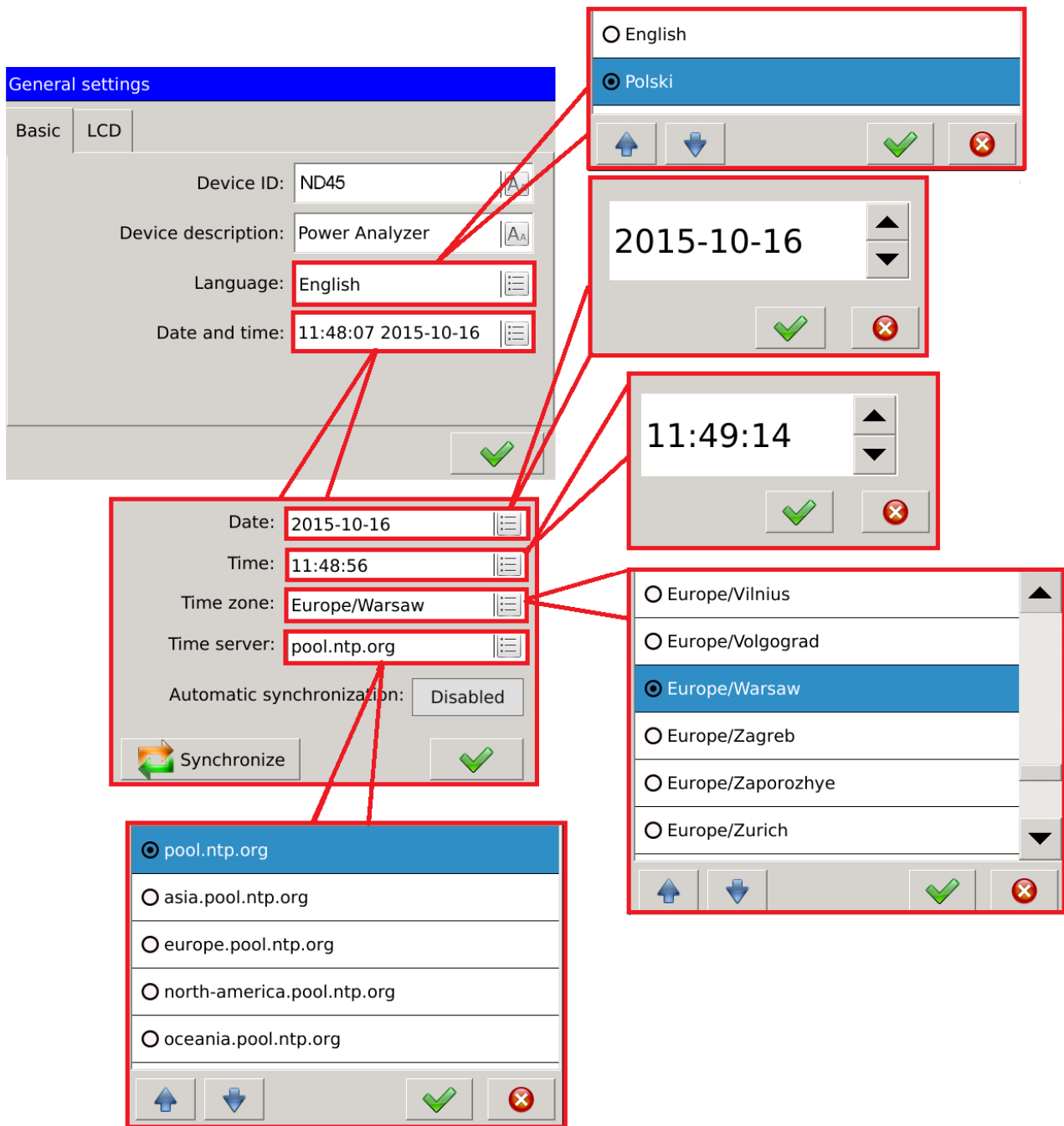
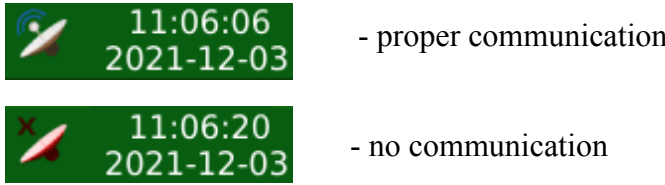

Fig. 109. General settings - basic.

Parameter	Description
Device ID	Assigned ID. The User can change the description.
Device description	Editable description of the device.
Language	This option allows the User to select the language of the device operation.
Date	Date
	Edit box to change the date of the device. The user selects the element of

and time		the date on the screen (year - month - day) which is to be modified by means of buttons ▲▼.
	Time	Editing time is carried out as described for the date. In this case the User edits the selected elements of time (hour - minute - second).
	Time zone	The selection list allows the User to select any time zone.
	Time server	Selection of time server providing the standard UTC time.
	GPS Synchronization	Enables cooperation with the STR receiver in order to synchronize the time with the GPS system. The communication status is indicated by the icon on the main screen, next to the system time.  
	Automatic synchronization	Enabling automatic synchronization makes it impossible to manually set the date and time that will be retrieved from the selected time server for the selected time zone. Disabling synchronization allows the User to specify their own date and time settings.
Synchronize	Forcing the synchronization of the system time in the application	

### 5.2.2. LCD settings

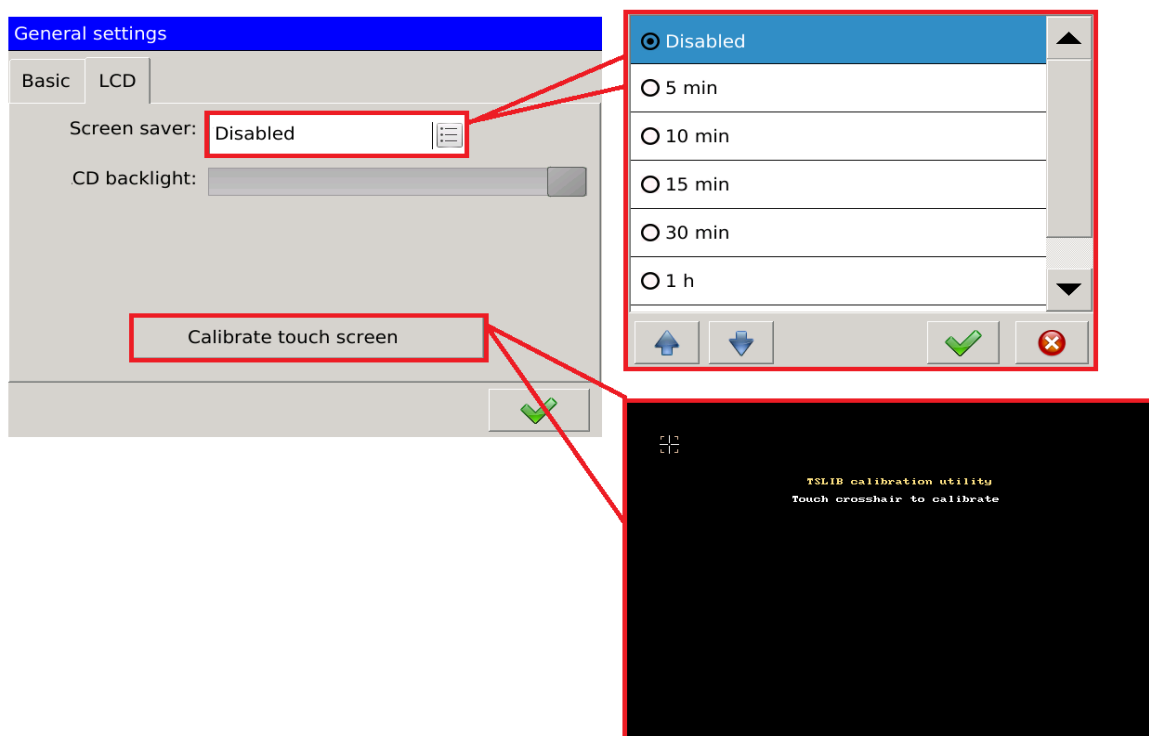

Fig. 110. General settings - LCD.

Parameter	Description
Screen saver	This option allows the User to enable or disable the screen saver. The User selects the time range from the list, after which the device's screen goes blank, or remains on.
LCD backlight	Adjusts the brightness of the device screen. Using the slider, the User changes the intensity of the backlight. The maximum value is set when the slider is moved to the right, moving to the left will reduce the brightness of the screen.
Calibrate touch screen	After selecting the calibration option the User will be redirected to the calibration window. In the next steps of the calibration the User must touch the points indicated on the screen. The screen is calibrated at five points, after calibration the device returns to the initial screen. Calibration of the screen cannot be stopped, when the screen is wrongly calibrated, the described process must be repeated.



### 5.3. Configuration of measurement input

#### 5.3.1. General settings

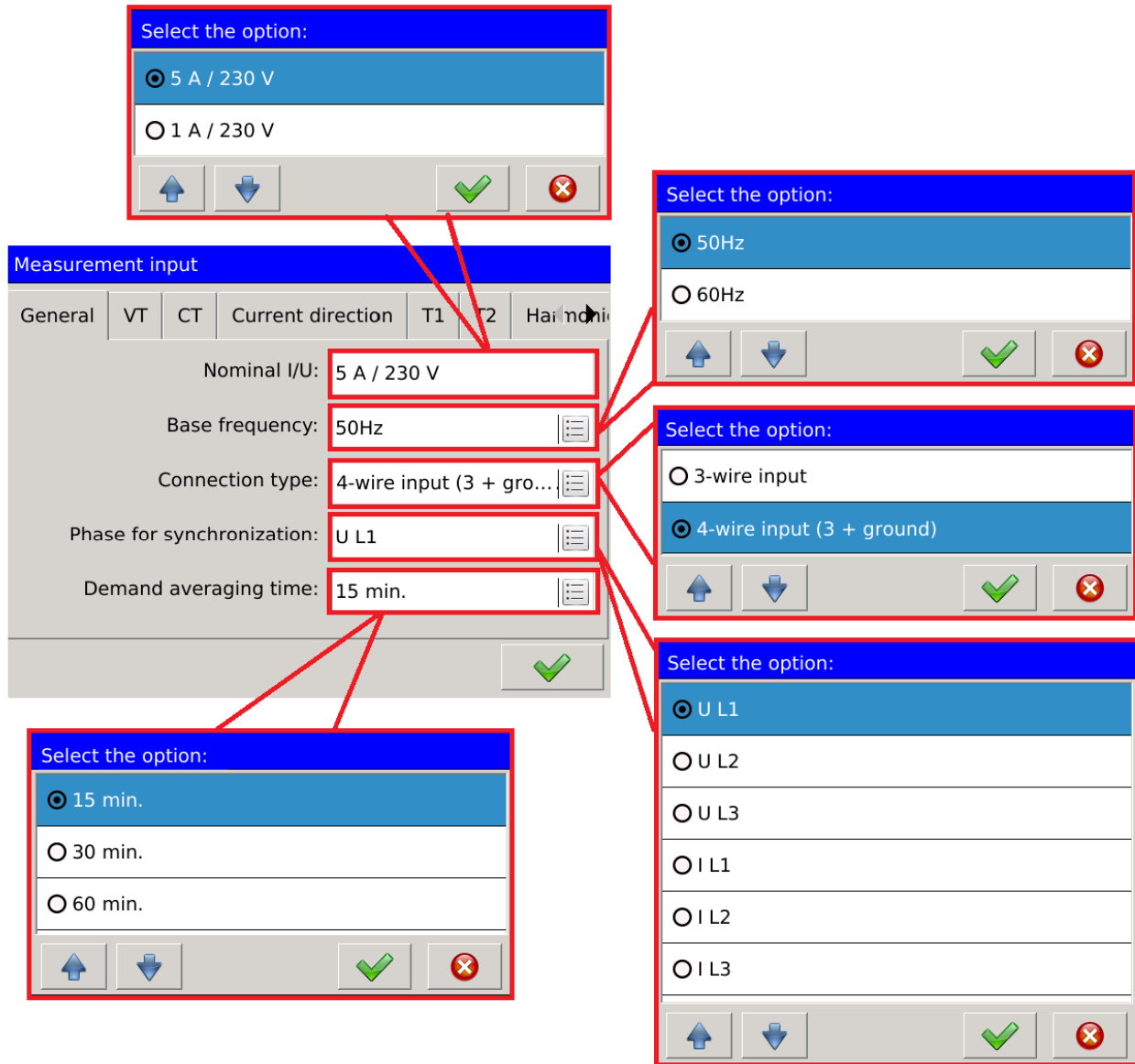

Fig. 111. Measurement inputs - general settings.

Parameter	Description
Nominal I/U	Selection of the nominal current and voltage for the device.
Base frequency	Selection of nominal frequency. For 50 Hz (measurement values from 150 periods), for 60 Hz (measurement values from 180 periods).
Connection type	Selecting the type of connection (3 or 4-wire).
Phase for synchronization	Parameter selection phase synchronization.
Demand averaging time	Setting the time range (defined in minutes) for the averaged parameters (Demand).

### 5.3.2. Voltage transformer ratio

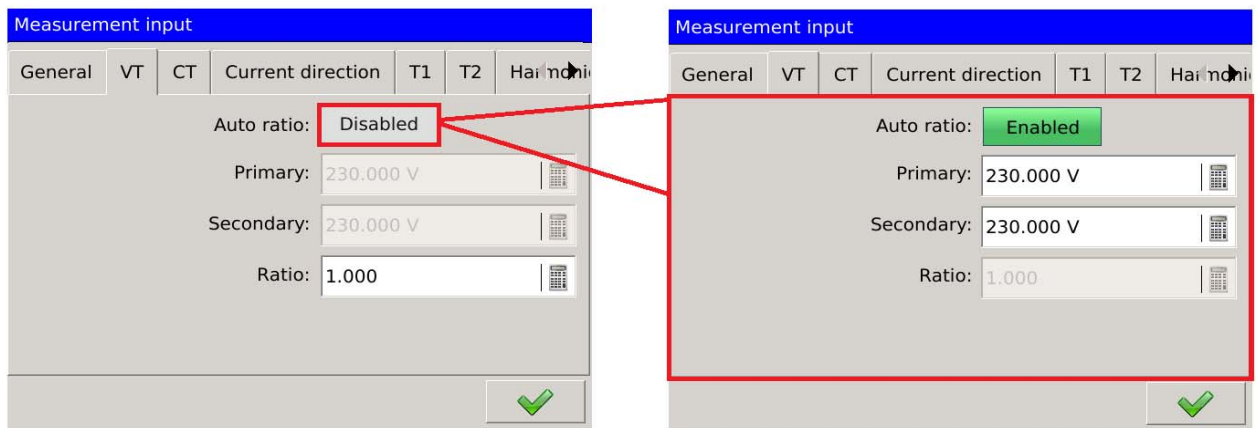

Fig. 112. Measurement input - voltage transformer ratio.

Parameter	Description	
Auto ratio	Enabling or disabling changes the method of voltage transformer ratio calculation.	
Primary	Primary voltage value.	The value of the voltage transformer ratio is calculated by dividing the primary value by secondary value.
Secondary	Secondary voltage value.	
Ratio	The value of voltage transformer ratio specified by the User.	

### 5.3.3. Current transformer ratio

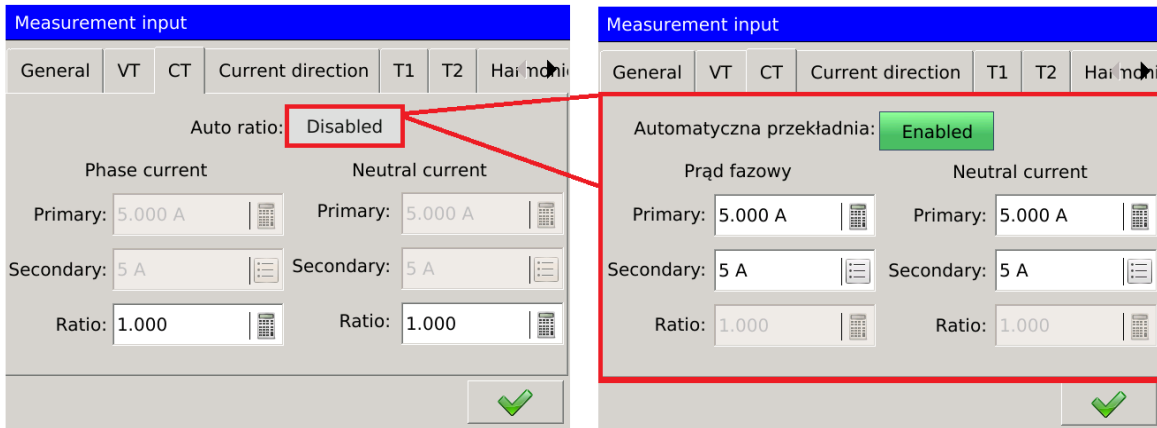

Fig. 113. Measurement input - current transformer ratio.

Parameter		Description	
Auto ratio		Enabling or disabling changes the method of current transformer ratio calculation.	
Phase current	Primary	Primary value of phase currents.	The value of the current transformer ratio is calculated by dividing the primary value by secondary value.
	Secondary	Secondary value of phase currents.	
	Ratio	The value of current transformer ratio specified by the User.	
Neutral current	Primary	Primary value of neutral currents.	The value of the neutral current transformer ratio is calculated by dividing the primary value by secondary value.
	Secondary	Secondary value of neutral currents.	
	Ratio	The value of neutral current transformer ratio specified by the User.	

### 5.3.4. Current direction

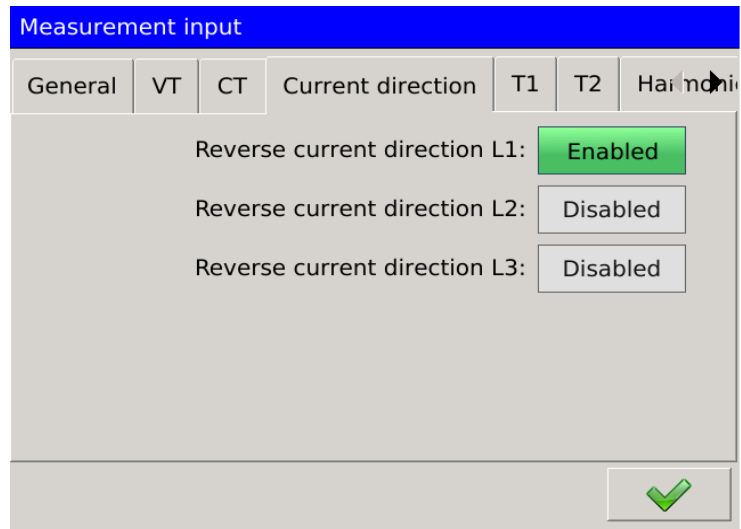

Fig. 114. Measurement input - current direction.

Parameter	Description
Reverse current direction L1 - L3	Fields allowing for reversing current direction for the individual phases.

### 5.3.5. Temperature and resistance

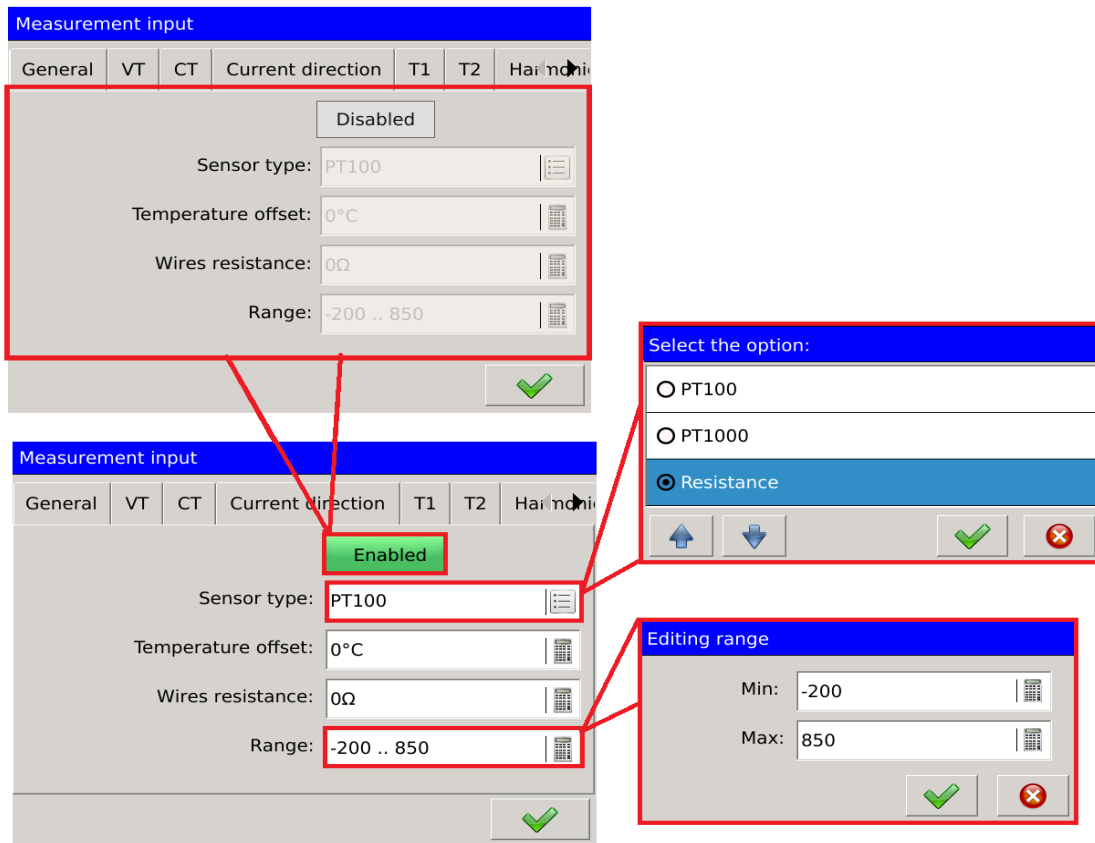

Fig. 115. Measurement input - temperature/resistance.

Parameter	Description
Enabled/Disabled	Enables or disables the function of temperature or resistance measurement.
Sensor type	Selection of the type of temperature (Pt100, Pt1000) or resistance sensor.
Temperature offset	Offset values for the measured temperature.
Wires resistance	Wires resistance values for the measured resistance value.
Range	Selection of the range for the selected sensor type. The User can change the standard minimum and maximum values assigned to the selected sensor.

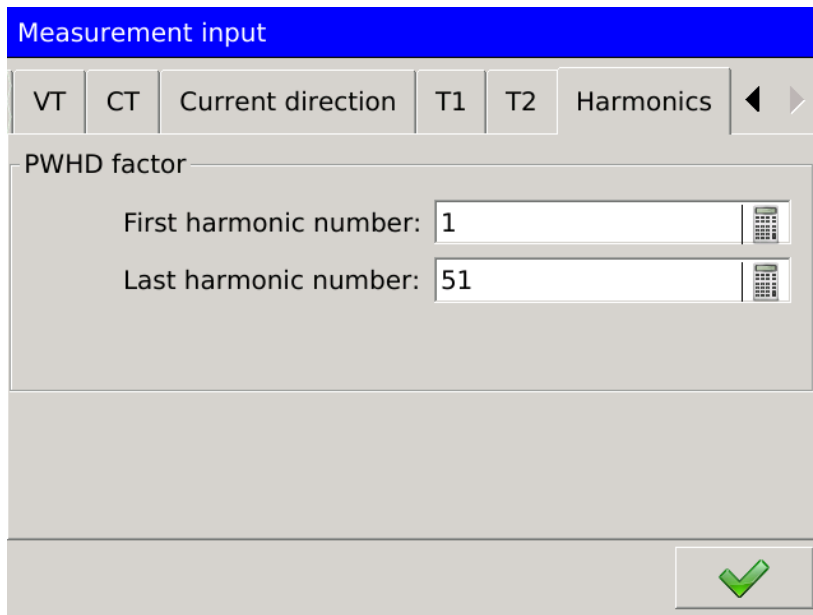

Fig. 116. Measurement input - temperature/resistance.

Parameter	Description
First harmonic number	Selection of the first harmonic for PWHD calculation.
Last harmonic number	Selection of the last harmonic for PWHD calculation.
Averaging time	Averaging time for harmonics and THD values for 1s, 3s, 10min, 2 hours.

5.3.7. External counters.

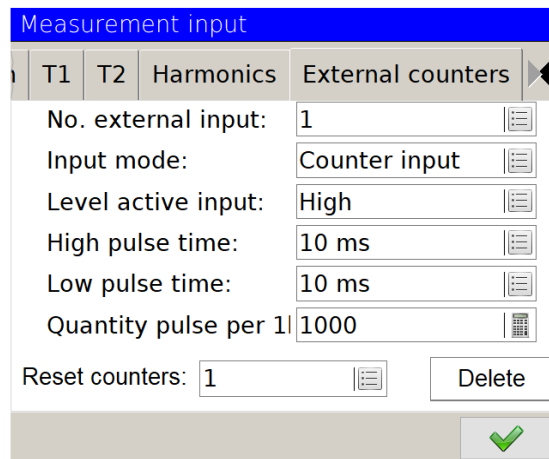

Fig.117. Measurement input - harmonics.

Parameter	Description
External input no	Allows to select the external input to be configured. After changing the input, the remaining configuration fields will display the currently set parameters.
Input mode	Operating mode selection. Depending on the settings, you can count only pulses or pulses with counters.
Input activity level	Selecting the level for which the input is to be active. The user chooses between Low and High level.
High level time	Time settings for high level: 1ms, 10ms, 100ms, 1s, 100s, 60s.
Low level time	Time settings for low level: 1ms, 10ms, 100ms, 1s, 100s, 60s.
Quantity of pulses per 1kW/h	Selection of calculator for counters. The user sets the number of pulses in the range from 1 to 100,000, which corresponds to 1 kW/h.
Resetting the counters	The selection list allows to choose any counter or all counters. Resetting selected counters will be done after pressing the Delete button.

### 5.4. Configuration of alarms

The window of alarms configuration allows the User to define up to twelve measurement outputs.

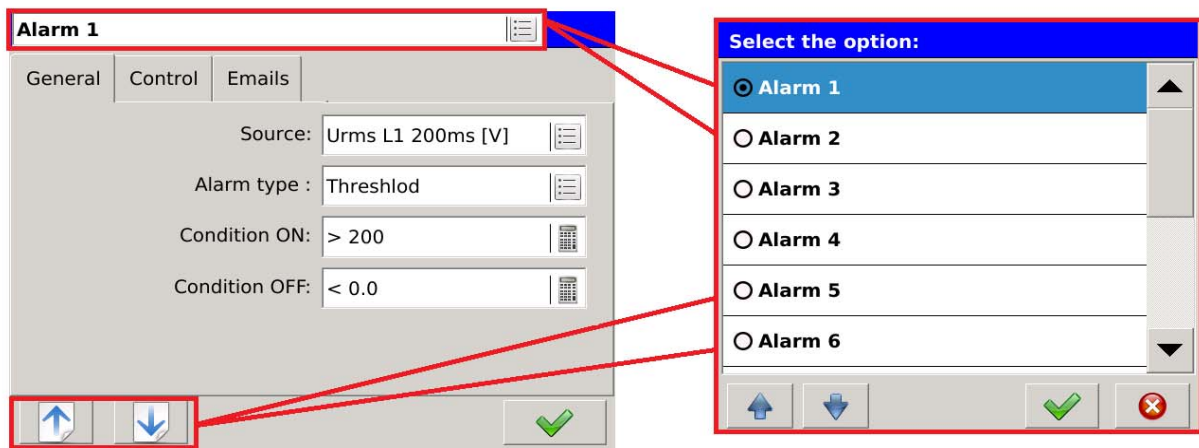



Fig. 118. Alarms - navigation.

Alarm configuration is assigned to a specific number. Navigating between successive alarms is done by means of buttons   or directly via the selection list at the top of the screen.

### 5.4.1. General settings

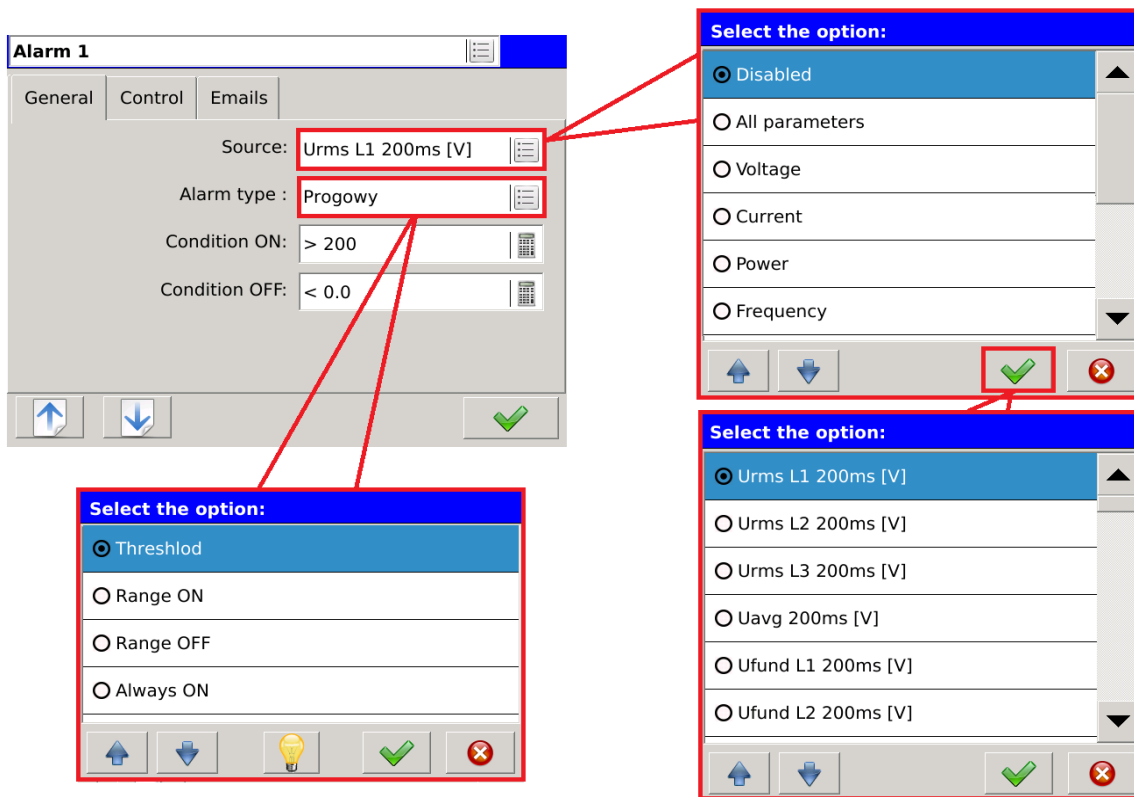
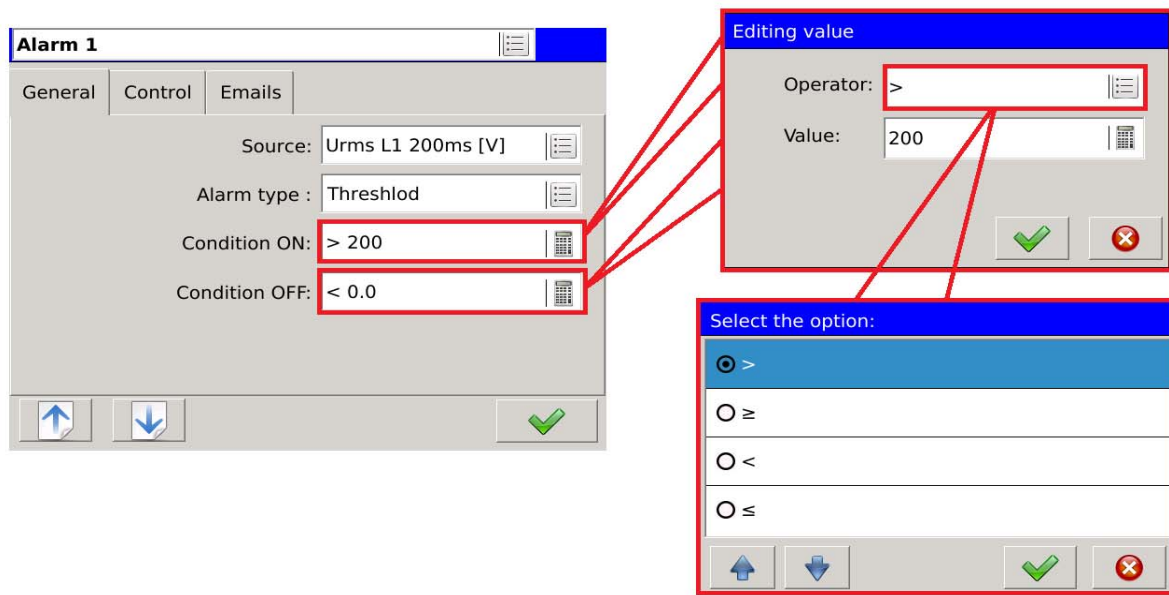

Fig. 119. Alarms - general settings.

Parameter	Description	
Source	Selection of the alarm source. First, the User selects the parameter group and in the next step, the selected parameter.	
Alarm type	Threshold	The alarm is activated if <b>Condition ON</b> is fulfilled, deactivated if <b>Condition OFF</b> is fulfilled.
	Range ON	The alarm is activated if the measured value is within a specified range. Value out of the range causes the alarm activation.
	Range OFF	The alarm is deactivated if the measured value is within a specified range. Value out of the range causes the alarm activation.
	Always ON	The alarm is always turned on.
Condition ON	Value of alarm activation.	
Condition OFF	Value of alarm deactivation.	





**Fig. 120. Alarms - general settings, conditional.**

Defining the condition of activation and deactivation the User defines the operator assigned to the condition and its associated value.

5.4.2. Control

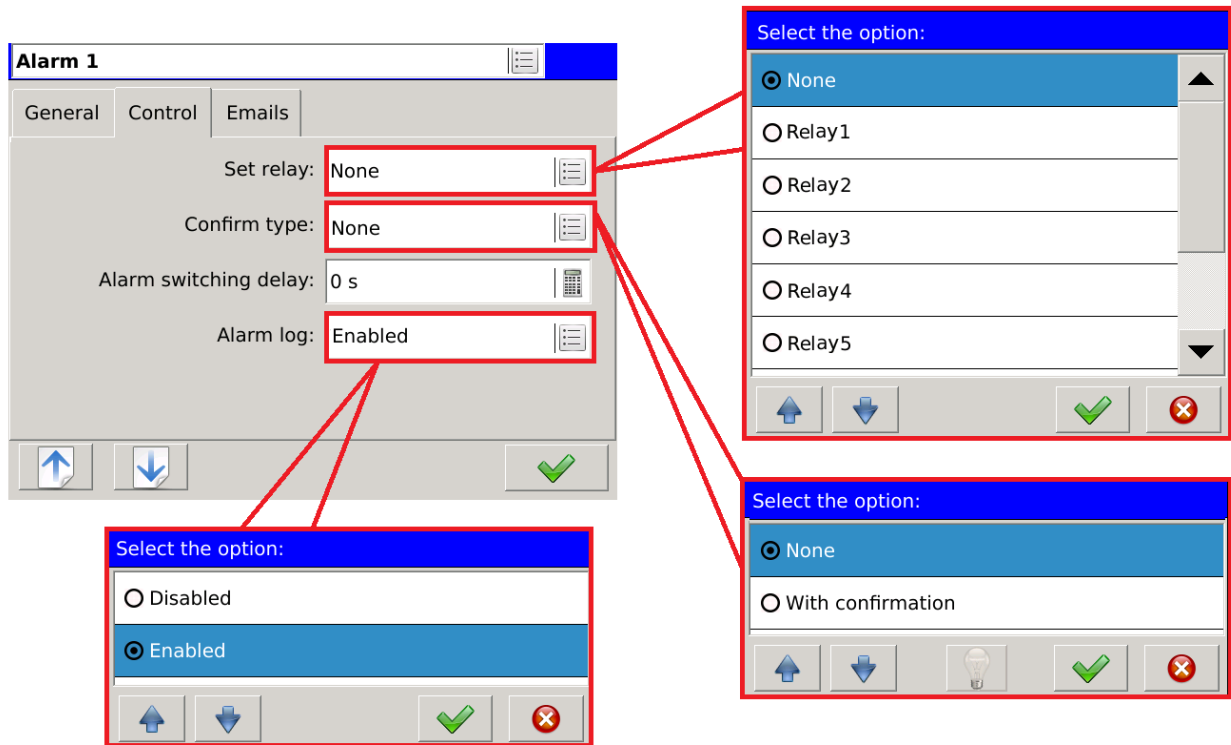

Fig. 121. Alarms - control.

Parameter		Description
Set relay		Assignment of relay to alarm output.
Confirm type	None	Turning off the alarm automatically deletes the information about the occurrence.
	With confirmation	After turning off the alarm, the information about the occurrence remains to be confirmed.
Alarm switching delay		Delay time of switching alarm states. After the event occurrence the alarm is activated or deactivated with the set delay time taken into account.
Alarm log		Sets the option which forces saving the events relating to the alarm to the alarm log (Alarms logs).

### 5.4.3. E-mail

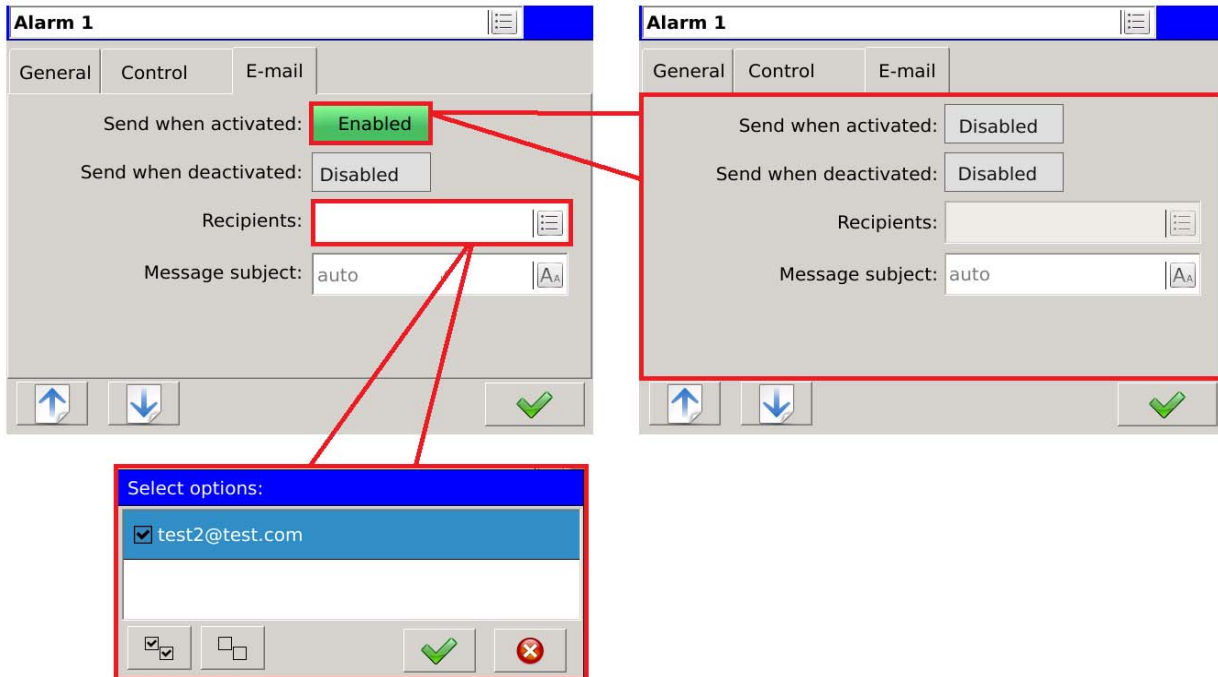

Fig. 122. Alarms – email.

Parameter	Description
Send when activated	Sending an e-mail with the information when the alarm is activated.
Send when deactivated	Sending an e-mail with the information when the alarm is deactivated.
Recipients	The selection list of the recipients to whom the message is sent. Recipients are defined under the <b>Ethernet</b> tab in the <b>Control Panel</b> .
Message subject	Edit box to define the subject of the e-mail. The default <b>Auto</b> option sends the message with the information about the alarm occurrence together with the ID and a description of the analyzer defined in the <b>General Settings</b> tab.

## 5.5. Configuration of visualization screens

### 5.5.1. Screens

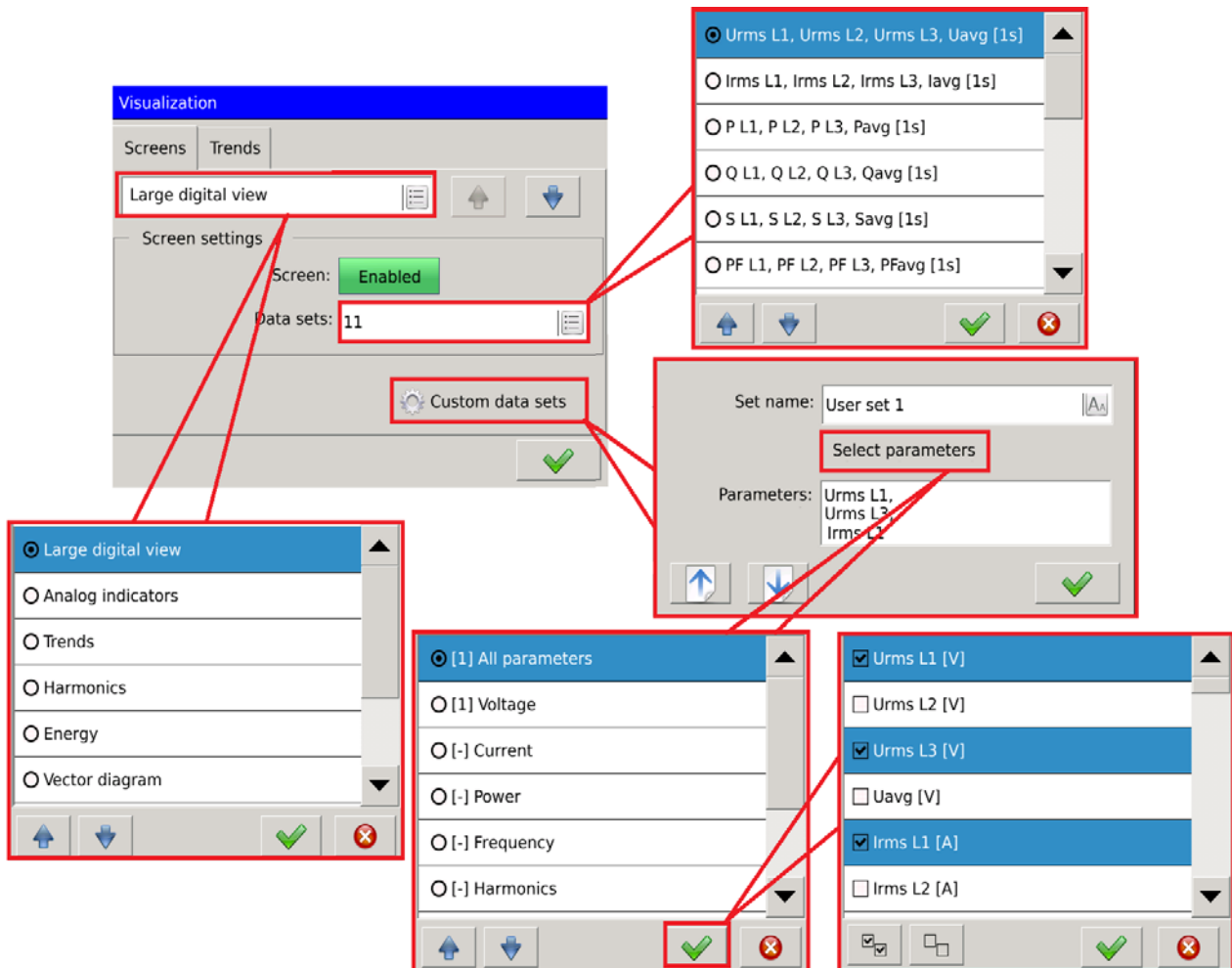





Fig. 123. Visualization – screens.

Parameter		Description
Large digital view		The User selects the type of the screen using the selection list (as shown in the example, or using the buttons   located on the right side of the selection list.
Screen settings	Screen	Disabling this option removes the view from the list of views displaying the measurement values of the screen.
	Data sets	The user can choose sets of views available to the currently selected screen type (in the example - Large digital view). The User can choose from default data sets and data sets defined individually (custom data sets).
Custom data sets	Set name	The user can define their own set name or keep the default name. By means of buttons   the User can navigate between the custom

	Parameters	<p>data sets.</p> <p>This function enables the User to select parameters for the custom data set.</p> <p>The group to which the parameter is assigned is selected first. The user is provided with the information about the parameters selected in the group. For example, designation [2] Voltage indicates that two parameters from the "Voltage" group were selected. Designation [-] indicates the lack of selected options in the group.</p>
--	------------	--

### 5.5.2. Trends

Screens of Trends view possible to be edited depend on the settings made in the tab **Visualization** → **Screens** → **Trends**.

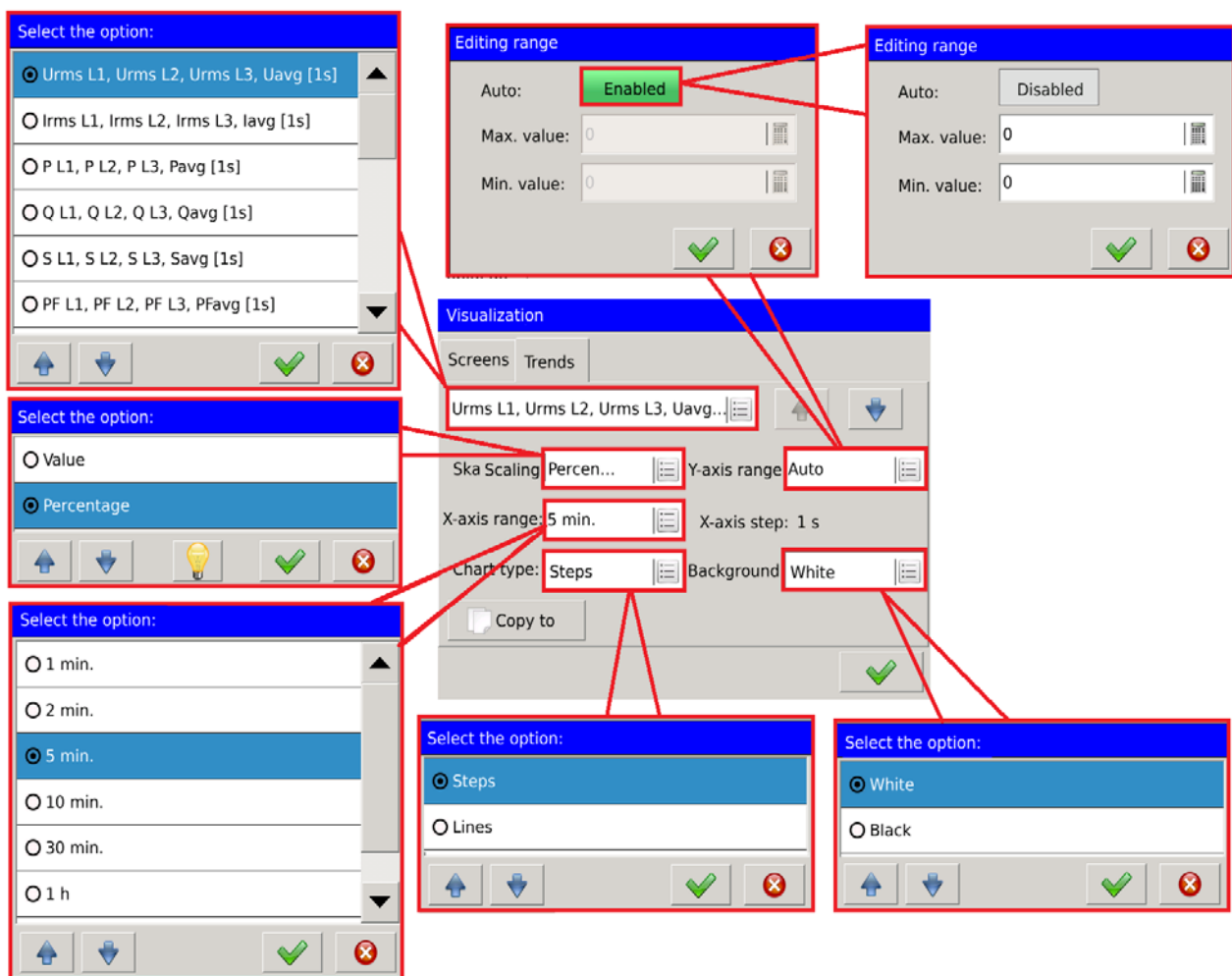

Fig. 124. Visualization – trends

Parameter		Description
Scaling	Value	Scaling to the parameter value.
	Percentage	Percentage scaling to the nominal value of the parameter range.
X-axis range		Time range of data presentation on the trends screen.
Chart type		The method of measured values presentation. Depending on the option selected the data is presented in a steps or lines.
Background		Selection of background color for the trends screen.
Y-axis range	Auto	Scaling option enabling or disabling affects the ability to edit the maximum and minimum values displayed on the Y-axis of the trends screen.
	Max. value	Maximum value of the Y-axis for the parameter presented on the trends screen
	Min. value	Minimum value of the Y-axis for the parameter presented on the trends screen

## 5.6. Configuration of Ethernet

### 5.6.1. General settings

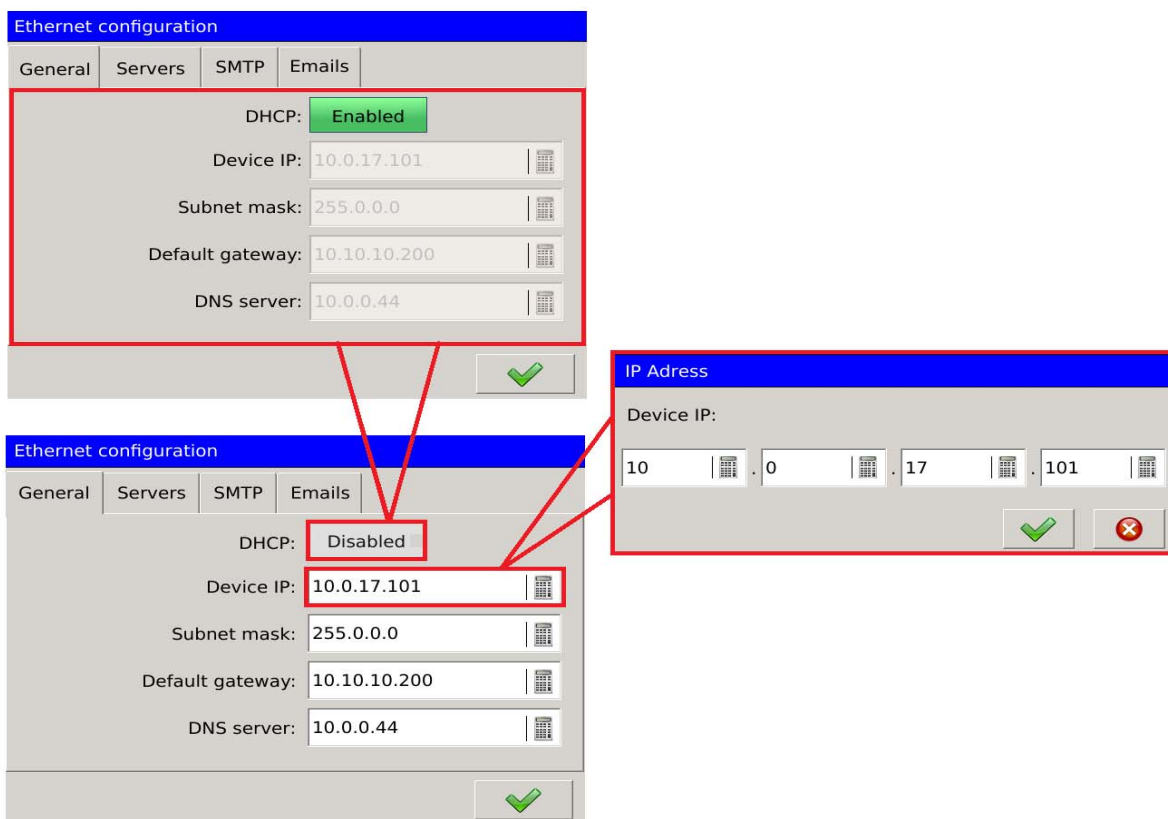

Fig. 125. Ethernet - general settings.

Parameter	Description
DHCP	Enables or disables DHCP. When enabled the service of automatic acquiring parameters of Ethernet interface IP protocol from external DHCP servers present within the same LAN is activated.
Device IP	Edit box for changing the IP address.
Subnet mask	Edit box for changing the subnet mask.
Default gateway	Edit box for changing the default gateway.

### 5.6.2. FTP and WWW Servers Settings

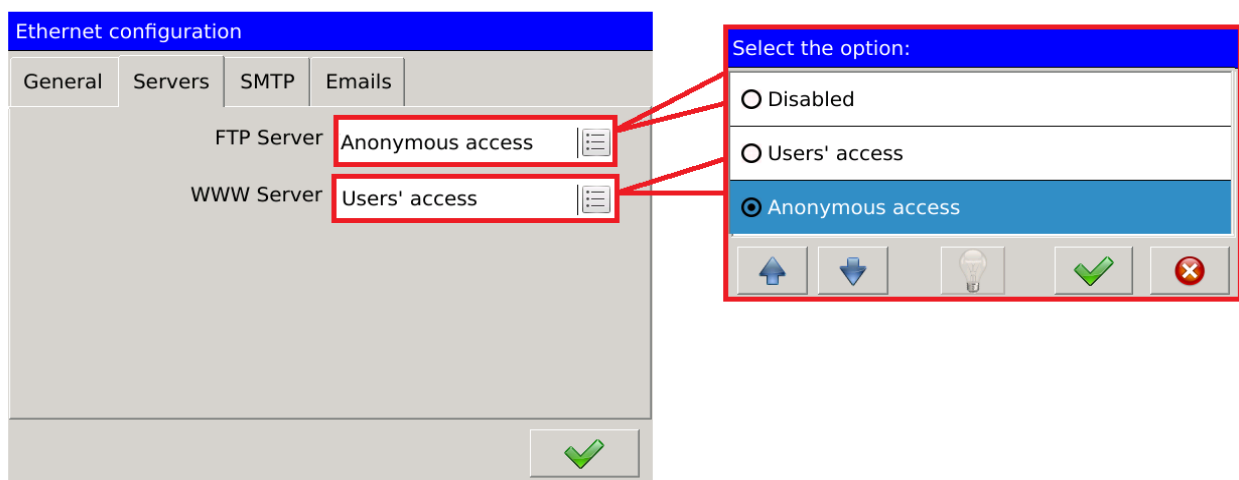

Fig. 126. Ethernet – servers.

Parameter	Description	
FTP server WWW server	Disabled	Lack of access to Web or FTP server.
	Users' access	Access requires authorization (login required)
	Anonymous access	Access does not require authorization (no login required)

### 5.6.3. Mail client settings

#### 5.6.3.1 SMTP configuration

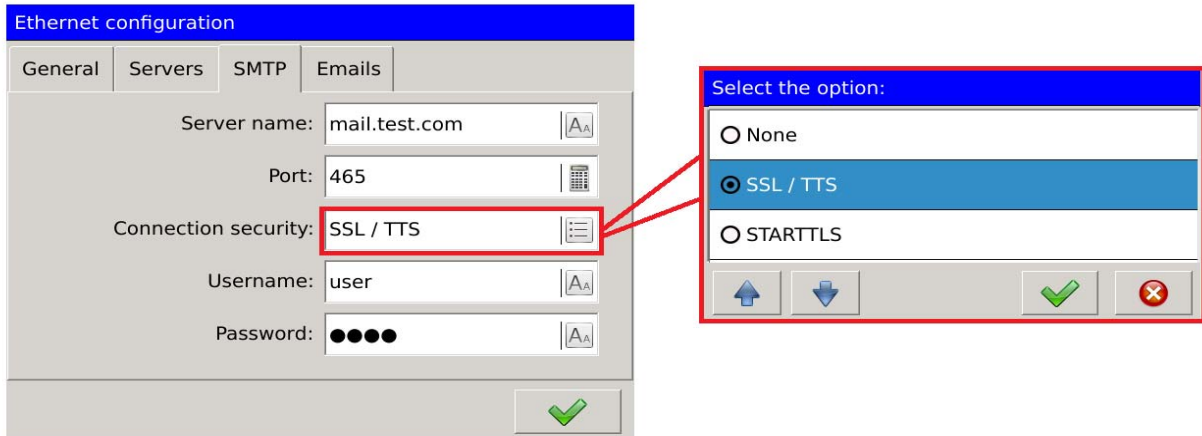

Fig. 127. Ethernet – smtp.

Parameter	Description
Server name	Outgoing mail server
Port	Outgoing mail server port
Connection security	Option to secure the outgoing mail
Username	Identifies the message sender
Password	Password to access the system

### 5.6.4. E-mail

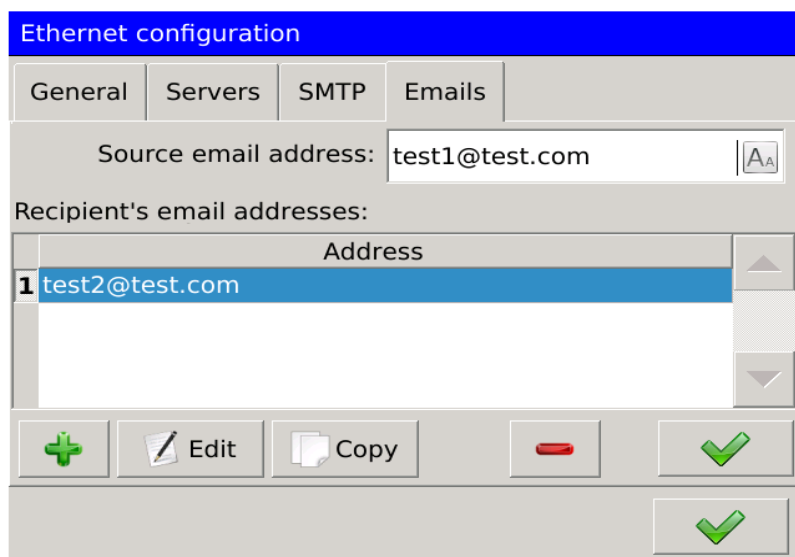



Fig. 128. Ethernet – email.



Parameter	Description
Source e-mail address	Outgoing mail server
Recipient's e-mail addresses	Lists of recipients' e-mail addresses with edit option. <b>Maximum 10</b> addresses in the list.
	Adding a new recipient address to the address list or remove the existing address from the list.
Edit	Changing the existing address in the list of recipients.
Send test mail	Sending a test message to the address in the list of recipients.

## 5.7. Configuration of Modbus

### 5.7.1 Configuration of Modbus RTU

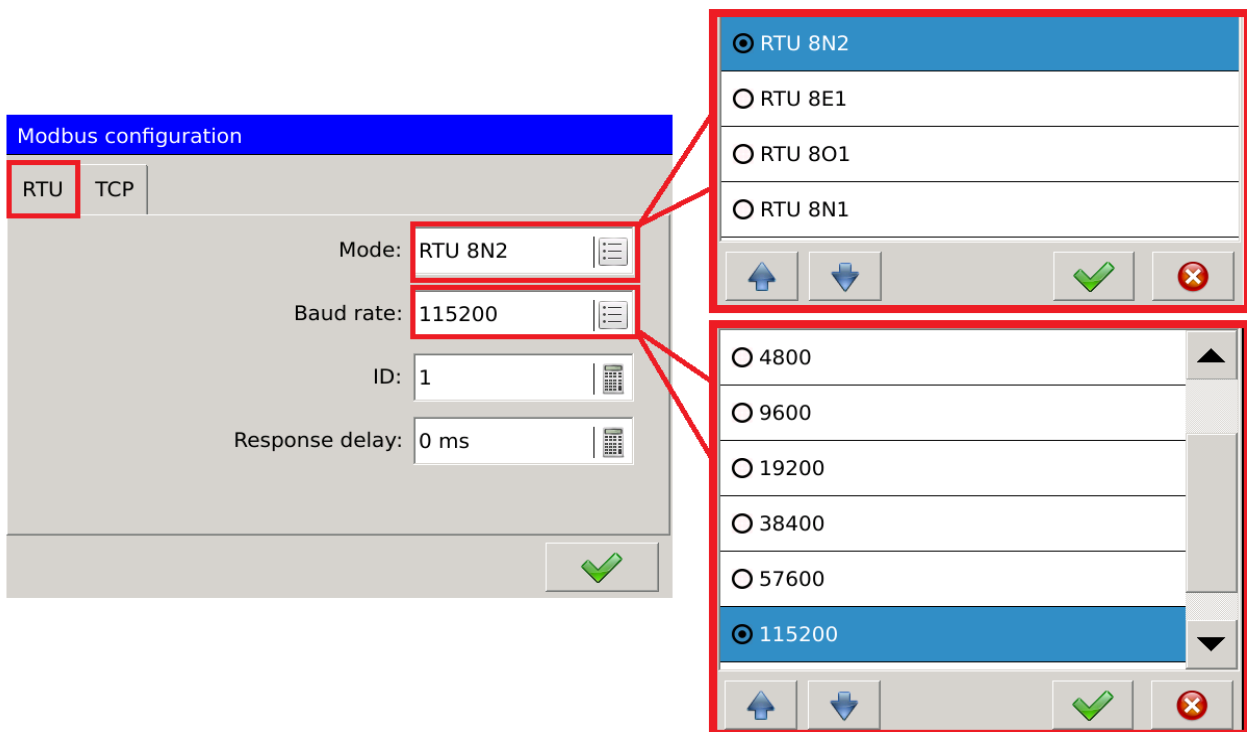

Fig. 129. Modbus slave.

Parameter	Description
Mode	Specifies the type of transmission frame of RS-485 interface.
Baud rate	RS-485 interface transmission speed.
ID	The device ID on the Modbus network.
TCP/IP	Enabling or disabling the Modbus TCP/IP mode.
TCP/IP port	Port number of Modbus TCP/IP protocol.
Response delay	Forced delay of response time.

### 5.7.2 Configuration of Modbus TCP

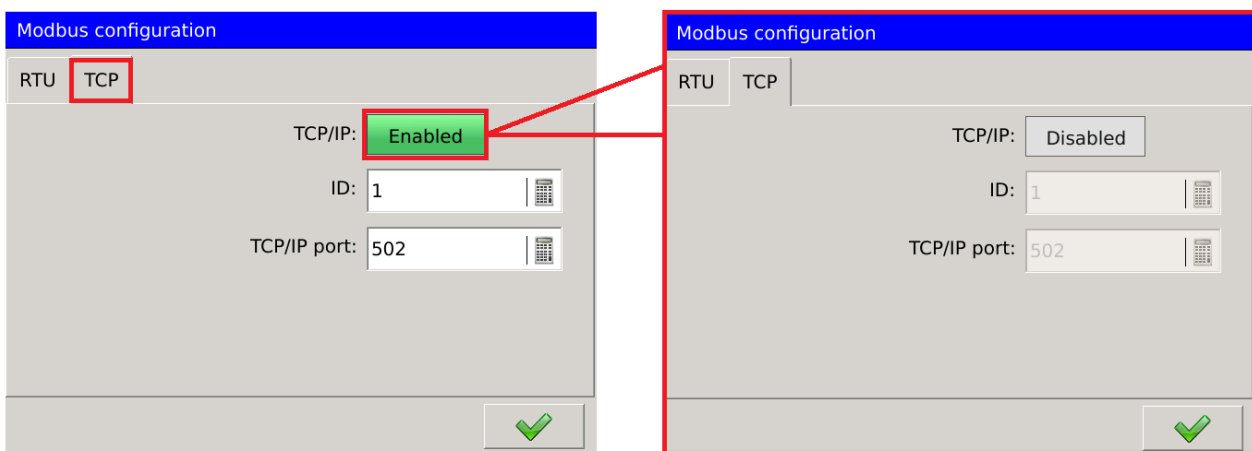

Fig. 130. Modbus TCP.

Parameter	Description
ID	The device ID on the Modbus network.
TCP/IP	Enabling or disabling the Modbus TCP/IP mode.
TCP/IP port	Port number of Modbus TCP/IP protocol.

## 5.8. Configuration of archiving

### 5.8.1. General settings.

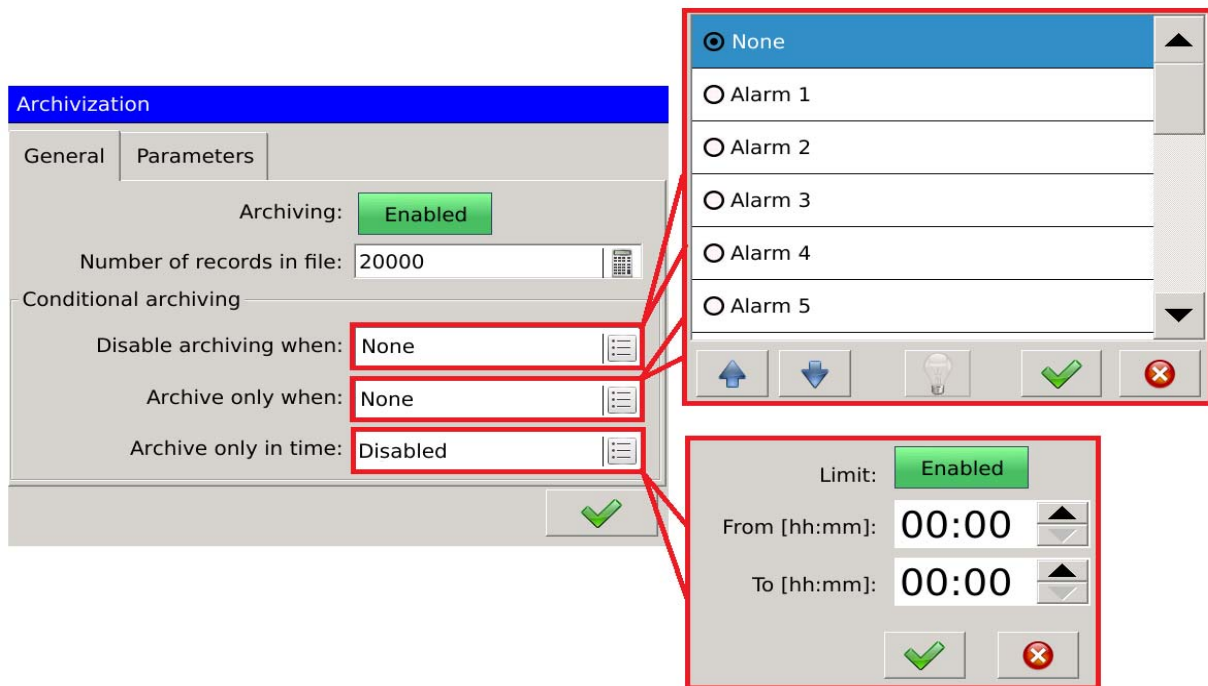

Fig. 131. Archiving - general settings.

Option	Description
Number of records in file	Specifies the maximum number of records possible to be saved to the file of archived values.
Enable archiving when	Assigning an alarm enabling archiving (when the alarm is active).
Disable archiving when	Assigning an alarm disabling archiving (when the alarm is active).
Archive only in time	Enabling this function activates archiving in the assigned time frame.
From [hh:mm]	The beginning of the specified time frame of archiving.
To [hh:mm]	The end of the specified time frame of archiving.

5.8.2. Parameters.

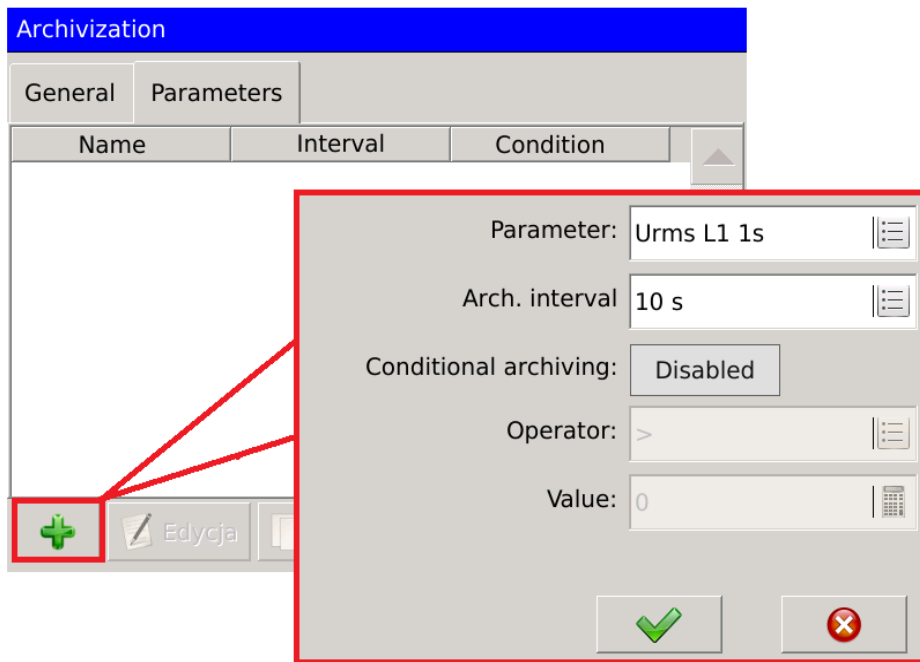

Fig.132. Archiving - parameters.

The table lists description of each option to add a new archived parameter.

Option	Description
Parameter	Selection of archived parameter.
Arch. interval	Selecting the archiving interval of the selected parameter.
Conditional archiving	Enabling or disabling conditional archiving.
Operator	Condition of conditional archiving
Value	Value assigned to the condition of conditional archiving.

**Caution!** The parameter Value should always be given in standard units (Urms : V, Irms : A itd.).

Sample configuration of archiving of Urms L1 voltage, aggregated every second. The parameter is archived every 10 seconds, conditional archiving is enabled.

First, the User selects the archived parameter and archiving interval.

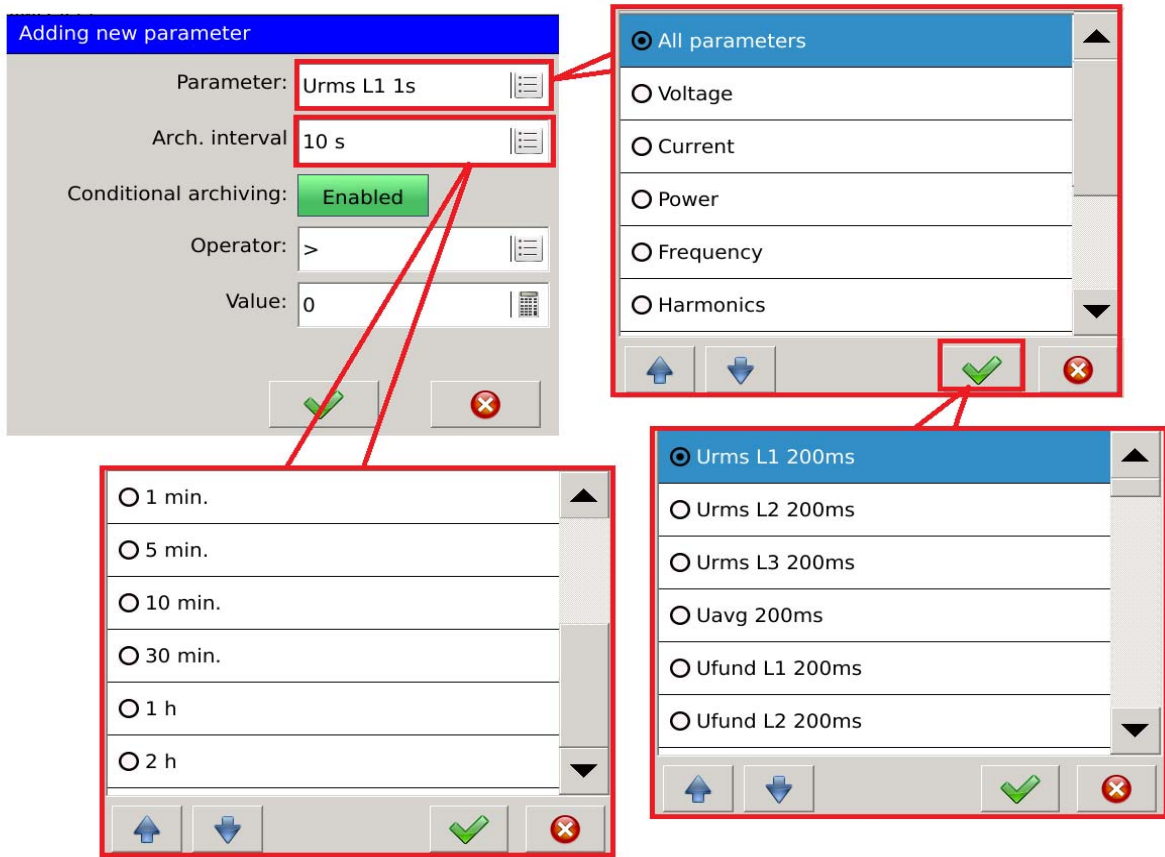

Fig. 133. Archiving – new parameter.

To set conditional archiving it is necessary to enable it and specify the condition which triggers archiving.

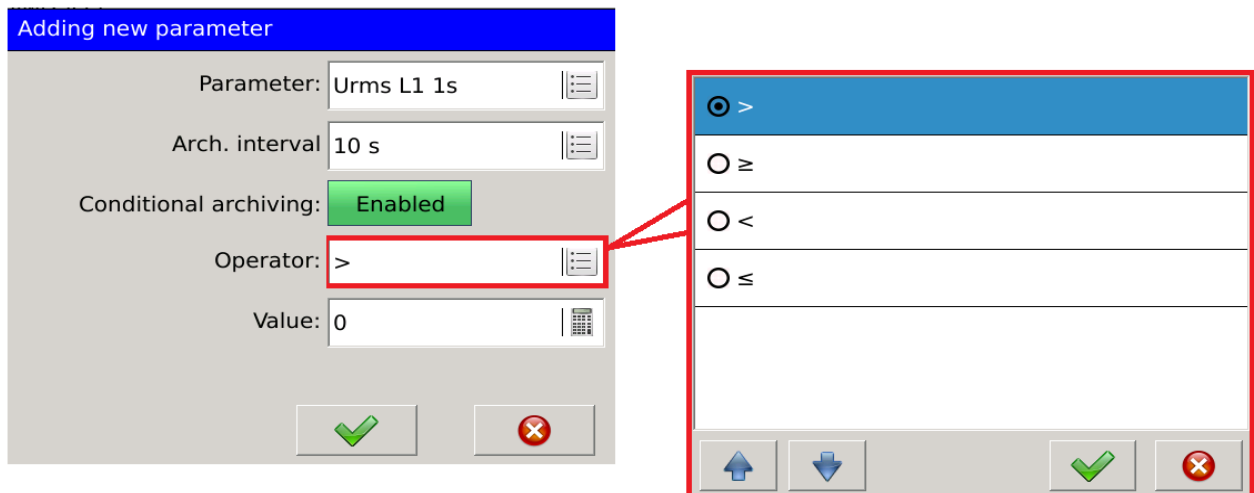

Fig. 134. Archiving – conditional.

The user can edit the configured parameter or create a new one on the basis of the existing one (using the copy option).

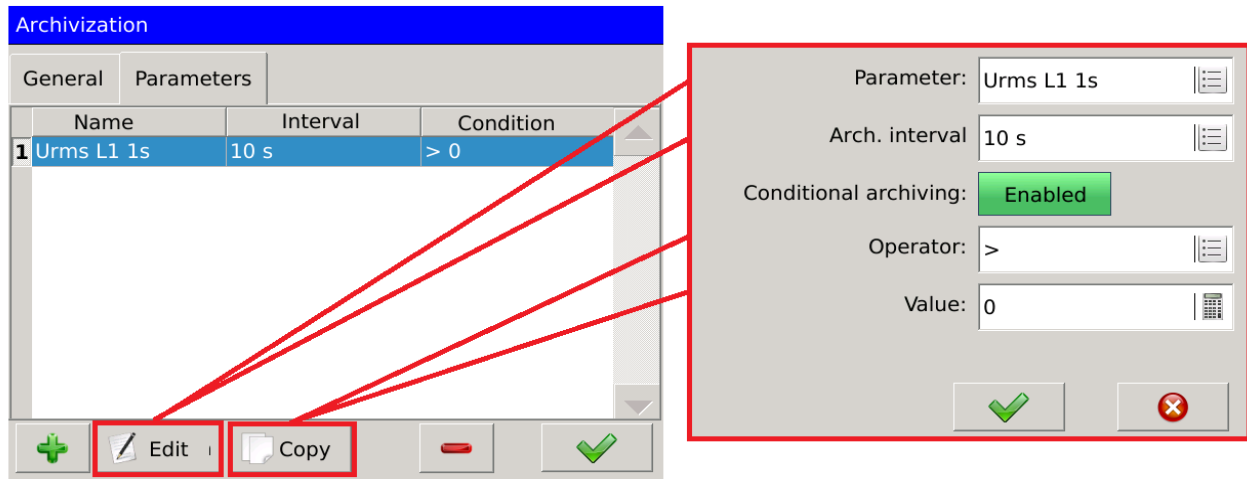

Fig. 135. Archiving – options.

### 5.9. Configuration of safety rules

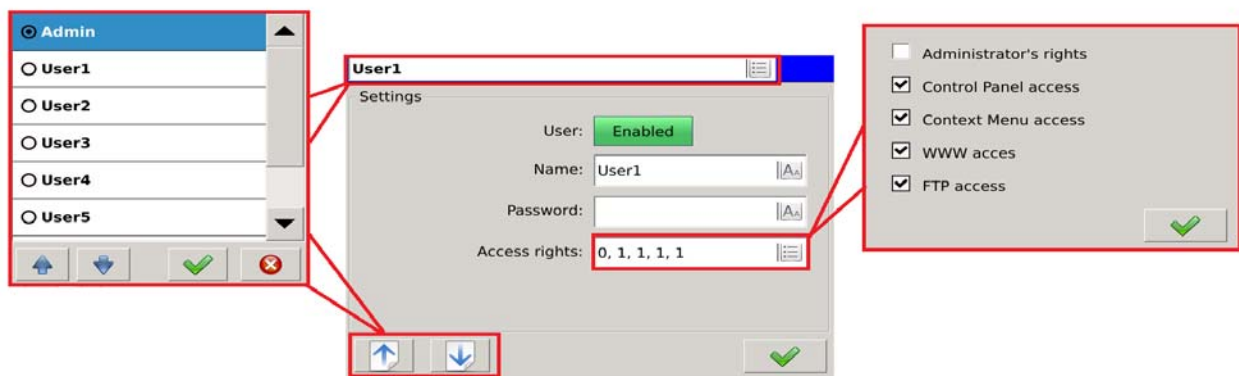



Fig. 136. Safety – navigation.

Navigating between the Users can be implemented by means of the selection list (turned on by touching the field at the top of the main screen (in the presented example with the currently selected

- Admin), or by means of buttons. .

Parameter	Description
User	Enabling or disabling the currently edited user.
Name	Editable user ID. It contains eight defined users. Default names: Admin, User 1, User 2 ... User 7.

Password		Password can be assigned for each user. Password is required to log in to the configuration settings.
Access rights	Administrator's rights	The authority to change the rights of users.
	Control Panel. access	It is possible to view and edit the parameters of the control panel.
	Context Menu access	It allows the User to confirm alarms in the context menu and additionally gives access to file management and alarms confirmation on the website.
	WWW access	Users' access to the website.
	FTP access	Users' access to FTP server.

### 5.10. Configuration of power quality

The image shows the 'Power quality' configuration window. It contains three input fields for 'Dips', 'Swells', and 'Interruptions', each with a calculator icon. Below these is a 'Log additional data' checkbox set to 'Enabled'. Three callout boxes, each titled 'Editing value', are connected to the calculator icons of the 'Dips', 'Swells', and 'Interruptions' fields respectively. Each callout box contains the following fields:

- Threshold value:** A text input field with a calculator icon. Values shown are 90% (for Dips), 110% (for Swells), and 1% (for Interruptions).
- Histeresis:** A text input field with a calculator icon. The value shown is 2% for all three.
- Values in percentage of the nominal voltage - Urms**
- Two buttons: a green checkmark (confirm) and a red 'X' (cancel).

Fig. 137. Power quality – settings.

Option	Description
Dips Swells Interruptions	Possibility to assign threshold values for the selected parameter and value of hysteresis. The values are calculated in relation to nominal voltage and expressed as a percentage.

Voltage dip - decrease in voltage to the value specified in the configuration (normally in the range from 90% to 1%) of the declared voltage, after which the voltage increases to the previous value. Usually dip duration ranges from 10ms to 1 minute.

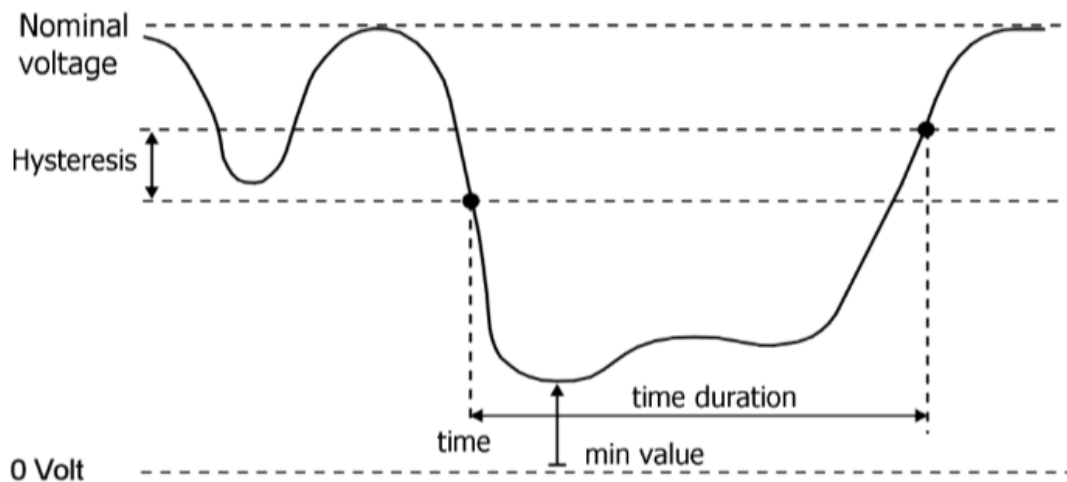

Fig. 138. Voltage dip.

Voltage swell - a temporary increase in the effective value of the voltage level exceeding a defined tolerance range specified in the configuration (normally 110%).

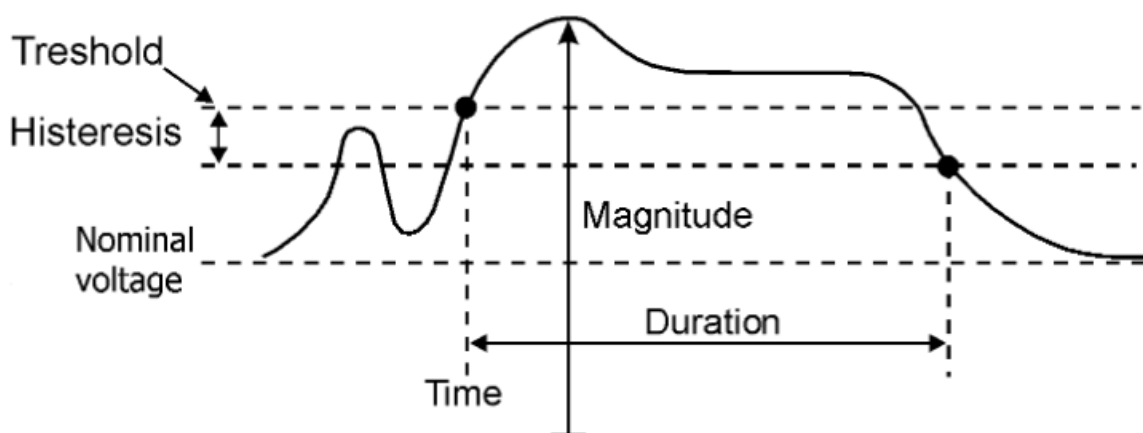

Fig. 139. Voltage swell.



Voltage interruption - the state in which the voltage is lower than the voltage defined in configuration (normally less than 1%).

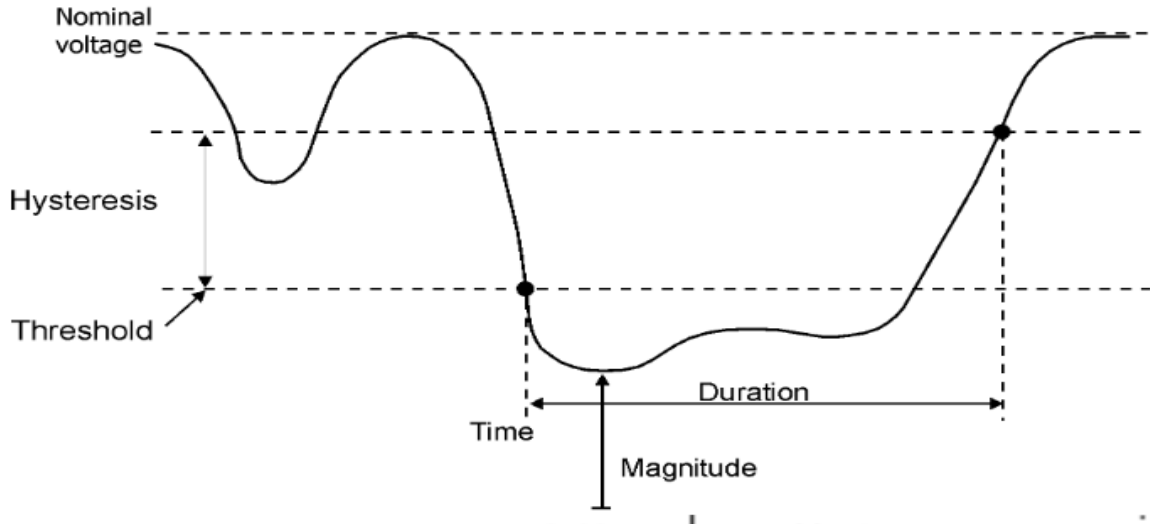

Fig. 140. Voltage interruption.

Event relating to dips, swells and interruptions are recorded in dips logs.

No.	Date	Time	Entry
3	2015-10-22	14:30:27.892	Interrupt (Urms L1):L1=0V
2	2015-10-22	14:30:19.631	Swell (Urms L1) : L1= 2
1	2015-10-22	14:30:10.303	Dip (Urms L2) : L1= 2:

Fig. 141. Power quality - log.

Option	Description
1	The number identifying the sequence of events related to dips.
2	The date of the event occurrence.
3	The time of the event occurrence.
4	The entry containing information about the event. The description includes the type of event, the value of half wave voltage of each phase and duration.
5	Examples of events related to voltage dips, swells and interruptions.

Logs related to dips, swells and interruptions are stored on the SD card. The file containing the current logs is saved as **dipswell.log.csv**.

Preview a file stored on the SD card is shown below.

```

1 2015-10-22 14:30:10.303 Dip (Urms L2) : L1= 216.376V L2= 202.172V L3= 227.747V czas: 00:00:03.378
2 2015-10-22 14:30:19.631 Swell (Urms L1) : L1= 254.71V L2= 292.273V L3= 251.197V czas: 00:00:04.406
3 2015-10-22 14:30:27.892 Interrupt (Urms L1) : L1=0V L2=0V L3= 0V czas: 00:00:02.029

```

**Fig. 142. Power quality - logs.**

Each file containing the events logs has a limited maximum size. After it is full another file **dipswell.log.csv** is created and the previously saved file is changed to **dipswell.log.1.csv** and when the entries in subsequent events logs are full **dipswell.log.2.csv**, **dipswell.log.3.csv** etc.

Additionally, the values preceding the event and the values occurring after the event are stored on the SD card. They are stored in the file **dipswellsamples.log.csv**.

## 5.11. Resetting the counters

Energy counters reset screen. The user indicates on the selection list which counters are to be reset. Below, they indicate which types of energy are to be cleared. The command will be carried out after selecting the Clear button.

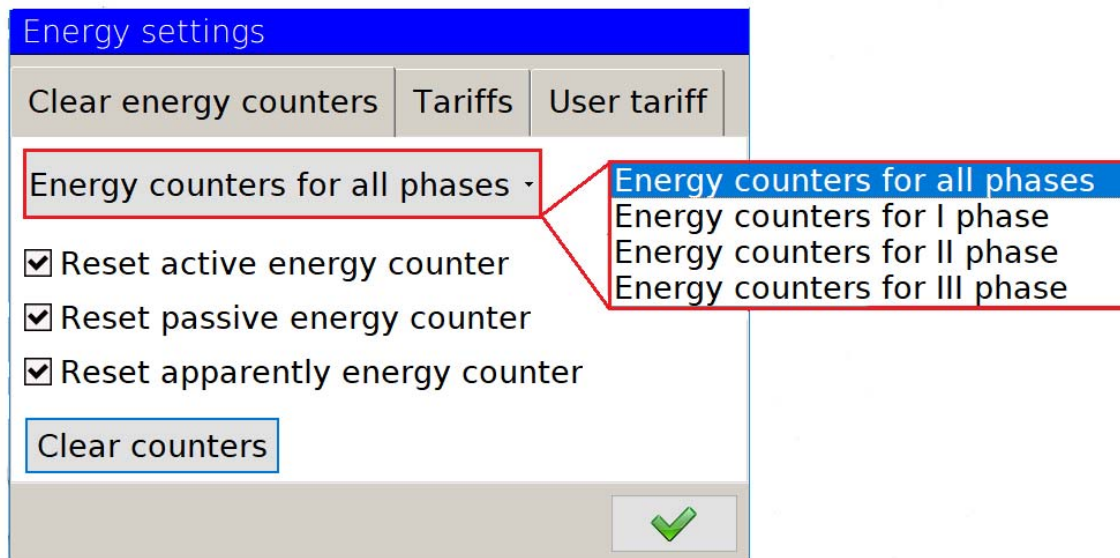

Fig.143. Resetting the counters.

### 5.12. Tariff configuration

ND40 analyzer allows the user to select one of two defined tariffs or a tariff set by the user.

Tariff B23

Tariff	T1	T2	T3	T4
January	7:00 am - 1:00 pm	4:00 pm - 9:00 pm	1:00 pm - 4:00 pm	9:00 pm - 7:00 am
February	7:00 am - 1:00 pm	4:00 pm - 9:00 pm	1:00 pm - 4:00 pm	9:00 pm - 7:00 am
March	7:00 am - 1:00 pm	4:00 pm - 9:00 pm	1:00 pm - 4:00 pm	9:00 pm - 7:00 am
April	7:00 am - 1:00 pm	7:00 pm - 10:00 pm	1:00 pm - 7:00 pm	10:00 pm - 7:00 am
May	7:00 am - 1:00 pm	7:00 pm - 10:00 pm	1:00 pm - 7:00 pm	10:00 pm - 7:00 am
June	7:00 am - 1:00 pm	7:00 pm - 10:00 pm	1:00 pm - 7:00 pm	10:00 pm - 7:00 am
July	7:00 am - 1:00 pm	7:00 pm - 10:00 pm	1:00 pm - 7:00 pm	10:00 pm - 7:00 am
August	7:00 am - 1:00 pm	7:00 pm - 10:00 pm	1:00 pm - 7:00 pm	10:00 pm - 7:00 am
September	7:00 am - 1:00 pm	7:00 pm - 10:00 pm	1:00 pm - 7:00 pm	10:00 pm - 7:00 am
October	7:00 am - 1:00 pm	4:00 pm - 9:00 pm	1:00 pm - 4:00 pm	9:00 pm - 7:00 am
November	7:00 am - 1:00 pm	4:00 pm - 9:00 pm	1:00 pm - 4:00 pm	9:00 pm - 7:00 am
December	7:00 am - 1:00 pm	4:00 pm - 9:00 pm	1:00 pm - 4:00 pm	9:00 pm - 7:00 am

Tariff B22

Tariff	T1	T2	T3	T4
January	8:00 am - 11:00 am	4:00 pm - 9:00 pm	11:00 am – 4:00 pm	9:00 pm – 8:00 am
February	8:00 am - 11:00 am	4:00 pm - 9:00 pm	11:00 am – 4:00 pm	9:00 pm – 8:00 am
March	8:00 am - 11:00 am	4:00 pm - 9:00 pm	11:00 am – 6:00 pm	9:00 pm – 8:00 am
April	8:00 am - 11:00 am	7:00 pm – 10:00 pm	11:00 am – 7:00 pm	10:00 pm – 8:00 am
May	8:00 am - 11:00 am	8:00 pm – 10:00 pm	11:00 am – 8:00 pm	10:00 pm – 8:00 am
June	8:00 am - 11:00 am	8:00 pm – 10:00 pm	11:00 am – 8:00 pm	10:00 pm – 8:00 am
July	8:00 am - 11:00 am	8:00 pm – 10:00 pm	11:00 am – 8:00 pm	10:00 pm – 8:00 am
August	8:00 am - 11:00 am	8:00 pm – 10:00 pm	11:00 am – 8:00 pm	10:00 pm – 8:00 am
September	8:00 am - 11:00 am	7:00 pm – 10:00 pm	11:00 am – 7:00 pm	10:00 pm – 8:00 am
October	8:00 am - 11:00 am	6:00 pm – 9:00 pm	11:00 am – 6:00 pm	9:00 pm – 8:00 am
November	8:00 am - 11:00 am	4:00 pm - 9:00 pm	11:00 am – 4:00 pm	9:00 pm – 8:00 am
December	8:00 am - 11:00 am	4:00 pm - 9:00 pm	11:00 am – 4:00 pm	9:00 pm – 8:00 am

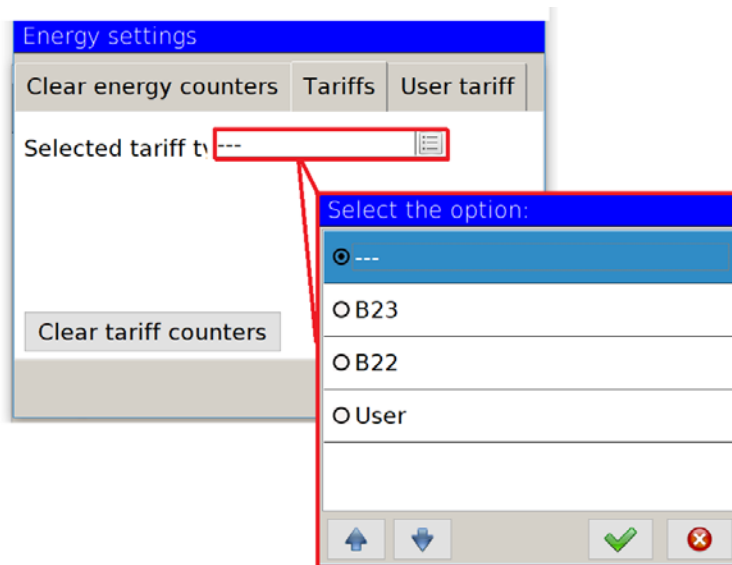

Fig. 144: Tariff selection.

User tariff settings.

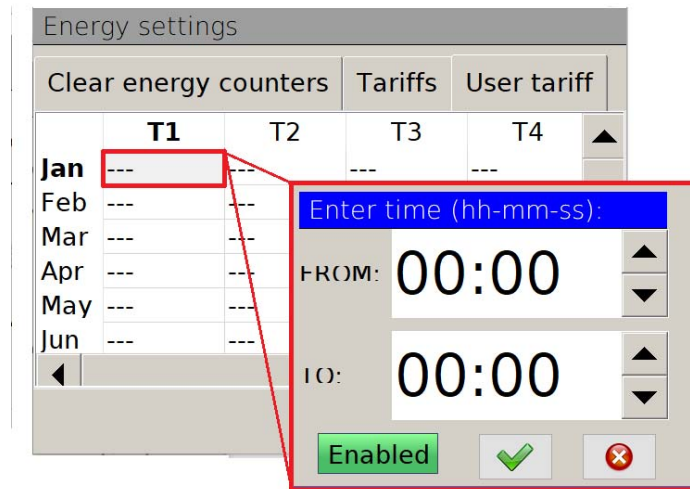

Fig. 145: User tariffs.

### 5.13. Configuration of outputs

Depending on the version of the analyzer the following options may be available in a limited form. In versions without additional inputs/outputs, none of the options will be available. Version with analog outputs will provide only the first option ((Analog outputs). The second option (Relays) is available for versions with relays (with 8 or 4 relay outputs).

### 5.13.1. Analog outputs.

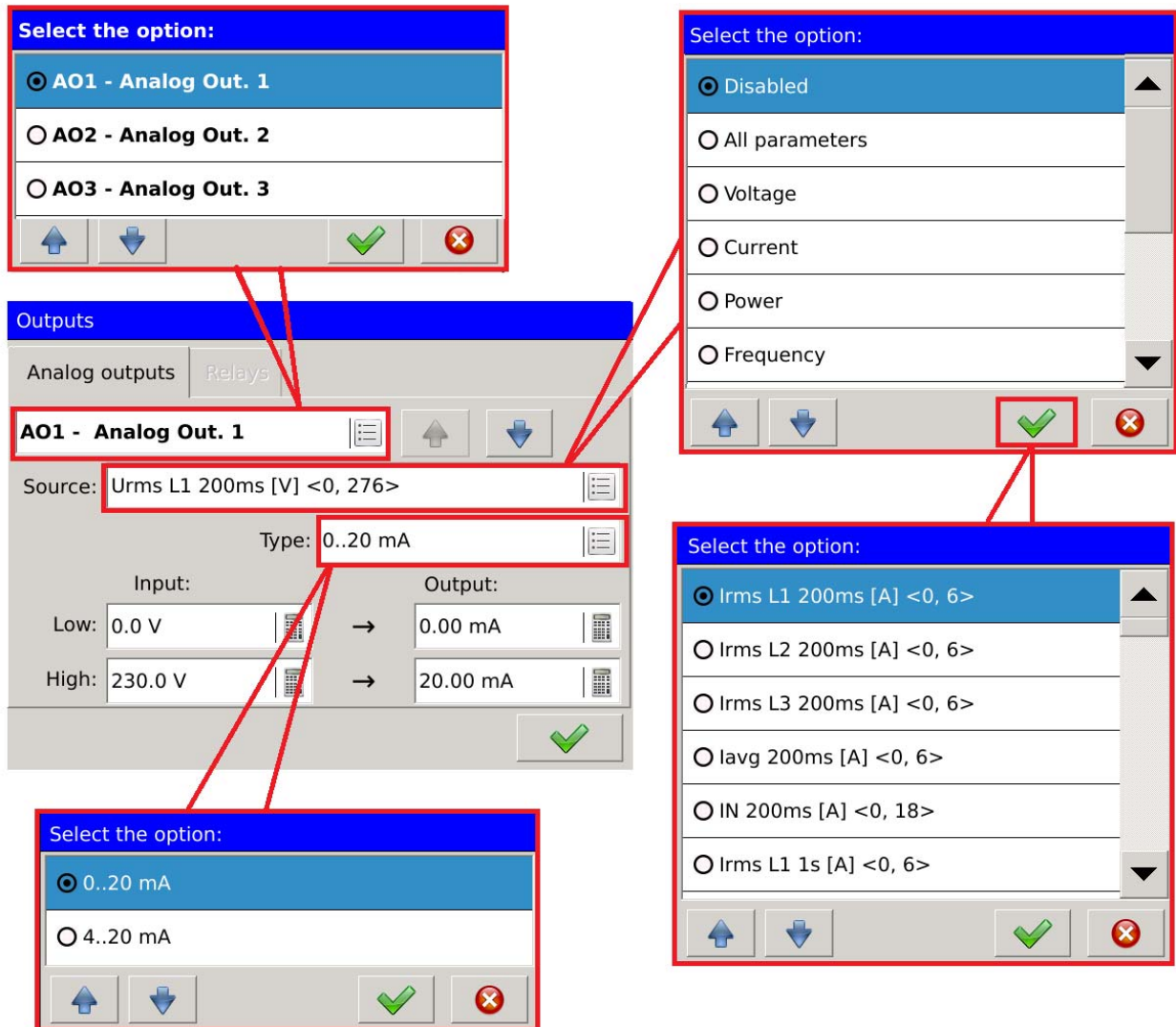

Fig. 146. Outputs - analog outputs.

Option	Description	
The number of the analog output	Selection of currently configured analog output.	
Source	Selection of output source assigned to the analog output.	
Type	Selection of range on the analog output.	
Input	Low	Lower value (of the input source).
	High	Upper value (of the input source).
Output	Low	Lower value (on the analog output).
	High	Upper value (on the analog output).

### 5.11.2. Relays.

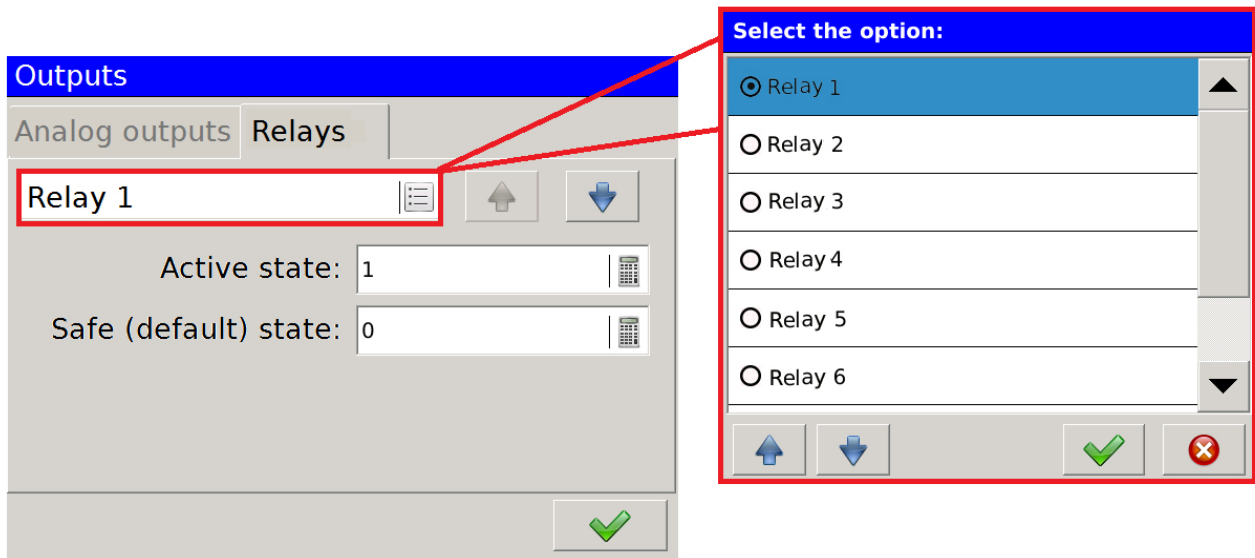

Fig. 147. Outputs - relays.

Option	Description
The number of the relay	Selection of the relay to be configured.
Active state	This value is set when the condition of alarm occurrence assigned to the given relay is fulfilled.
Safe (default) state	This value is set when the hard linked value is not ready.

## 6. File manager

The User can edit the files stored on the SD card or USB host on the analyzer by means of the file manager.

Switching to the file management is shown below.

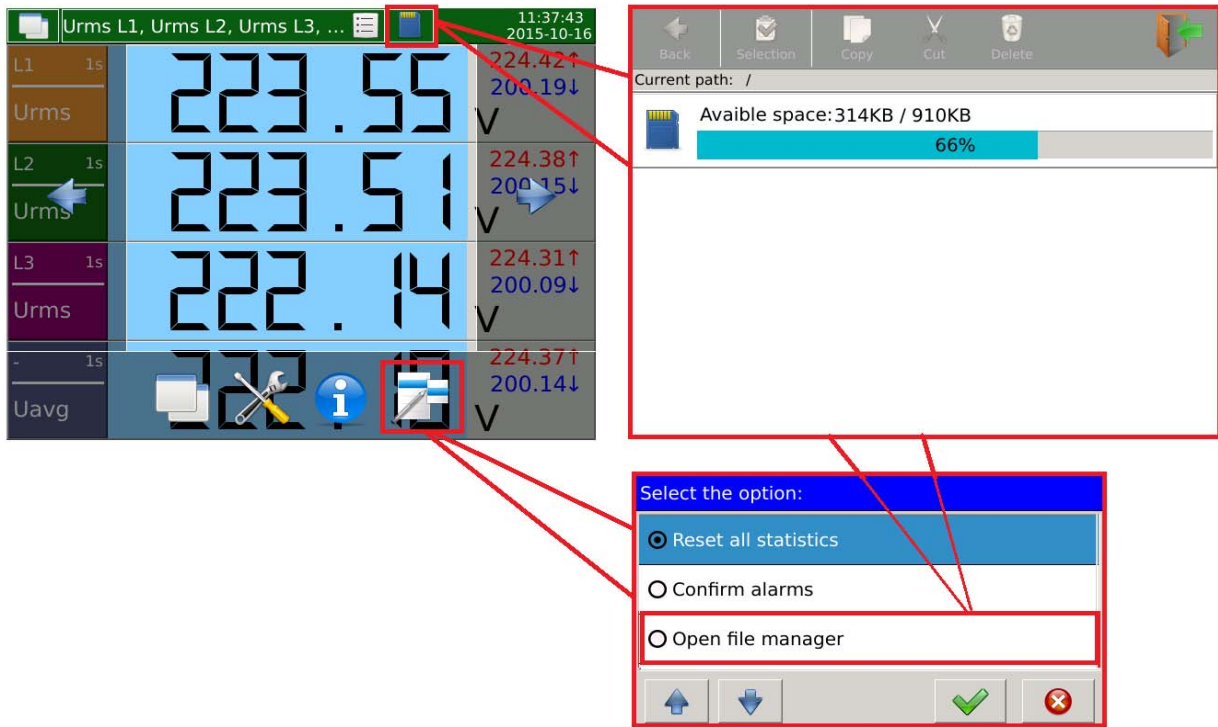

Fig. 148. File manager – navigation.

After selecting the edited resource in the form of an SD card or USB host the User can edit the stored files. The example of selecting a file from the SD card together with the assigned editing options is shown below.

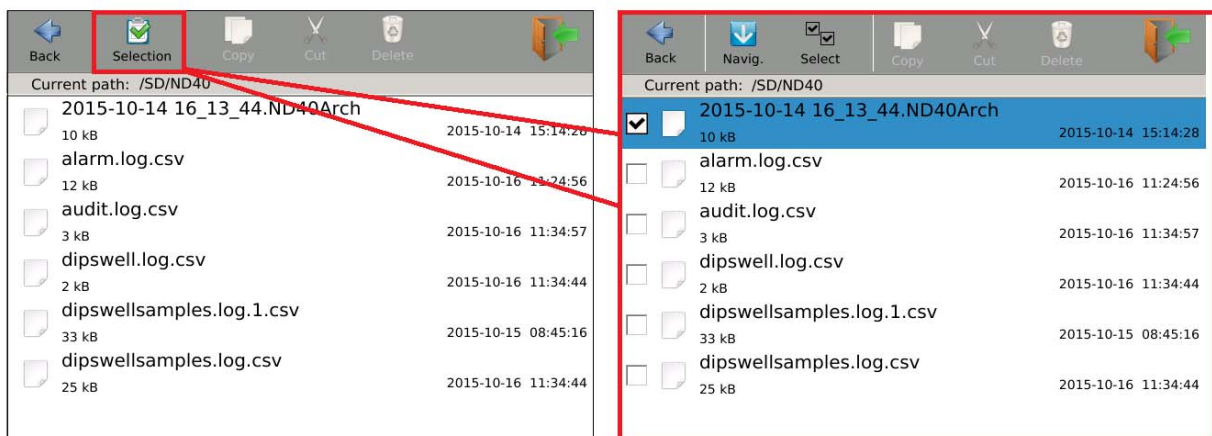





Fig. 149. File manager - selection of files.



Option	Description
 <p data-bbox="248 394 421 421"><b>Fig. 150. Copy.</b></p>	Copies the selected item to any desired location on the memory card.
 <p data-bbox="248 564 421 591"><b>Fig. 151. Cut.</b></p>	Moves the selected item to any desired location on the memory card.
 <p data-bbox="248 734 421 761"><b>Fig. 152. Delete.</b></p>	Deletes the selected item from the memory card.
 <p data-bbox="248 927 421 954"><b>Fig. 153. Exit.</b></p>	Exits the file manager.

## 7. Configuration of WWW

To start the server, the User must configure the Ethernet. The access type must be assigned to the WWW server option. Setting this option to Off prevents the connection with the server.

**Caution!** Detailed information in section 5.6. *Configuration of Ethernet.*

Setting Users' access (WWW server fully functional) is possible after setting access rights for individual users.

**Caution!** Detailed information in section 5.9. *Configuration of safety rules.*

## 8. Configuration of FTP

To start the server, the User must configure the Ethernet. The access type must be assigned to the FTP server option. Setting this option to Off prevents the connection with the server.

**Caution!** Detailed information in section 5.6. *Configuration of Ethernet.*

Setting Users' access (FTP server fully functional) is possible after setting access rights for individual users. In addition, in the authorized mode a password must be assigned to the User.

**Caution!** Detailed information in section 5.9. *Configuration of safety rules.*

## 9. Data archiving

Configuration of archiving parameters is shown in section 5.8. *Configuration of archiving.*

Screenshot of the analyzer showing the management window with currently set parameters for archiving.

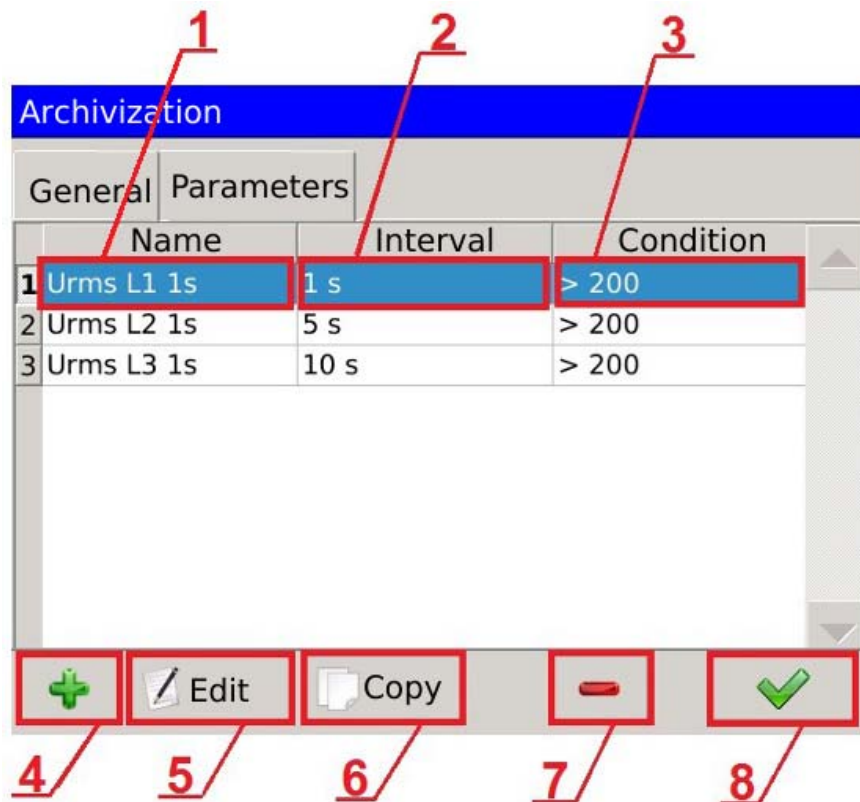

Fig. 154. Archiving - parameters.

Item	Description
1	Archived parameter.
2	Archiving interval.
3	Conditional archiving - the condition of archiving.
4	Adds a new parameter for archiving.
5	Edits the selected archiving parameter.
6	Copies the configuration of the selected parameter and saves it as a new parameter for archiving.
7	Deletes the selected archived parameter.
8	Confirms the changes.

Downloading archiving files is possible via the Web server ( *3. Web server management*).

Sample file with archived data. 11/12/2015 13\_24\_21.ND45Arch

The name of the file includes the date and time the file was created. The example describes the last archived file (all records set during the configuration of archiving were full).

After making changes in the configuration of archiving, e.g. by adding new parameters or changing the conditions of archiving, a new file with the time and date of its creation is created.

Archiving files are saved in a format compatible with SQLite.

Each file contains basic information about the archived parameters:

- id - automatically assigned records ID,
- idParameters - parameter identifier that is compatible with the number of parameter defined in the archiving tab→parameters,
- dateTime - date and time of the archived parameter,
- value - archived value of the parameter.
- flag - the state of the archived values:

0 – correct measurement

1 – no measurement value

128 - the process of the averaging of values for a given time window is not finished.

The archive files can be read out using a dedicated application PowerArchive (provided by LUMEL), by means of the Web Server (*3.2.20 Preview of archive files*), or any application that supports the database format compatible with SQLite.

## 10. Alarms

In the standard version the analyzer of network parameters ND45 is equipped with four relay alarm outputs.

The rules for alarms configuration are described in *5.4 Configuration of alarms*.

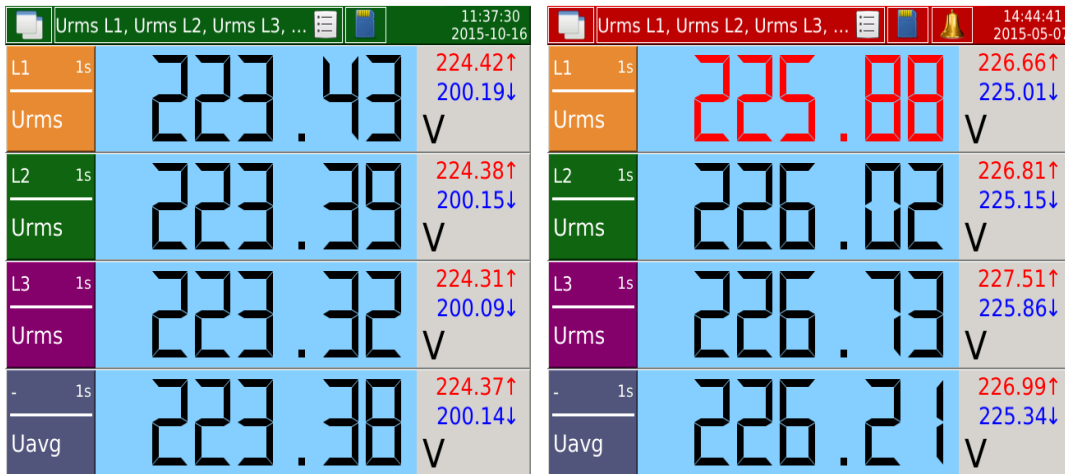

Fig. 155. Alarms - visualization.

The view on the left shows the operating mode in which no alarm activation event has occurred, the view on the right the operating mode with activated alarm.

Alarm activation changes the color of the information bar at the top of the screen from green to red. Moreover, an additional element is generated .

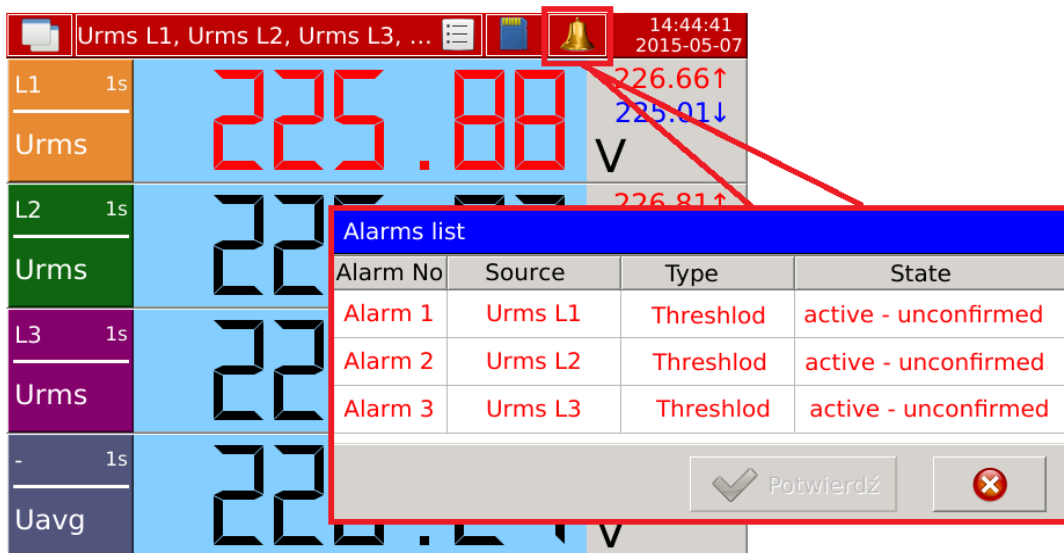

Fig. 156. Alarms - list.

After selecting the element generated at the time of the alarm activation, the list with currently activated alarms will be displayed.

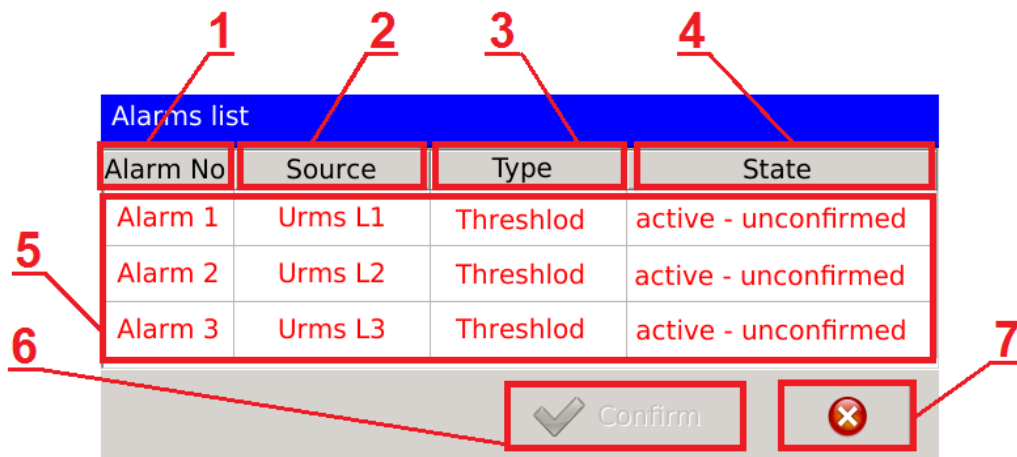

Fig. 157. Alarms - list of alarms, description.

Option	Description
1	Number of the alarm, set by the User.
2	Value assigned to the alarm. The value of the parameter activates or deactivates the alarm.
3	Type of alarm assigned to the displayed event.
4	Current state of the alarm.
5	Main window with information about alarms occurrence.
6	Function allowing for alarms confirmation.
7	Exit the dialog box.

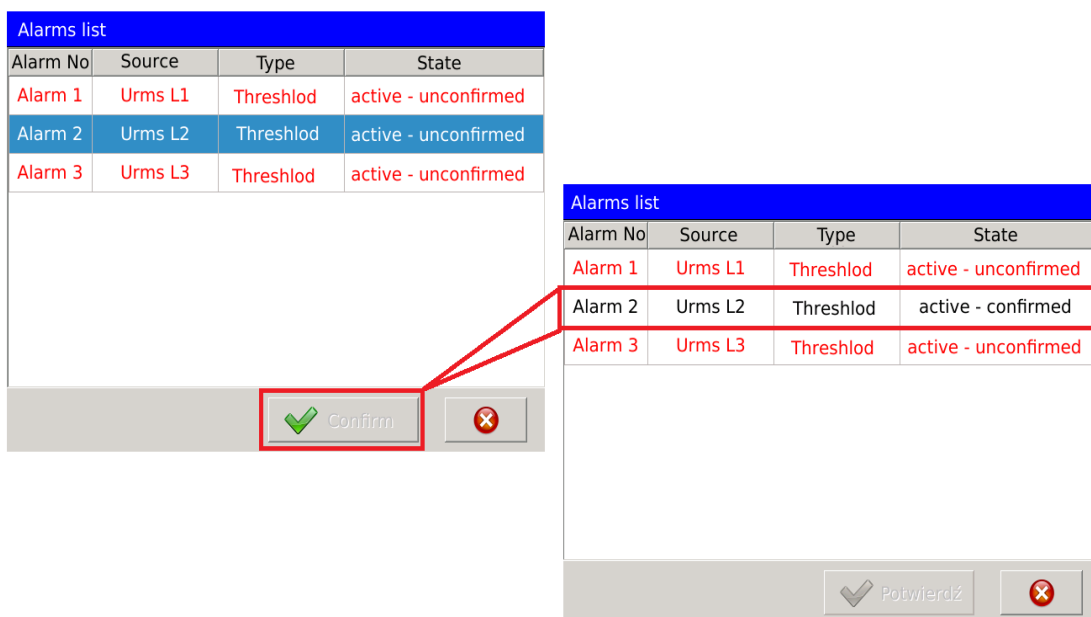

Fig. 158. Alarms - confirmation.

Confirmation of the selected alarm changes the way the alarm is displayed in the alarm list. The font color and the description of the state of the alarm are changed.

In the event the option to report the state of the alarm in alarms logs was selected in the alarm configuration, the events related to the activation or deactivation of the alarm will be saved.

Alarm log			
No.	Date	Time	Entry
4	2015-05-06	11:55:52	Alarm 3 - Off (Urms L3 = 0V)
3	2015-05-06	11:55:44	Alarm 3 - On (Urms L3 = 222.18...
2	2015-05-06	11:55:39	Alarm 3 - Off (Urms L3 = 0V)
1	2015-05-06	11:55:34	Alarm 3 - On (Urms L3 = 224.11...

Fig. 159. Alarms - logs.

Option	Description
1	The number identifying the sequence of events related to alarms.
2	The date of the event occurrence.
3	The time of the event occurrence.
4	The entry containing information about the event. The description contains the identifier of the alarm, the event and the value causing the event.
5	Examples of events related to the alarms.

Alarm logs management is performed as shown in the example below. Option *Clear the logs*, clears the saved entries from the log window. Option *Confirm alarms*, redirects to the previously described dialog box where selected alarms can be confirmed. Options to clear and confirm require User's rights confirmation. When this option is selected, a dialog box is displayed in which the User enters the user name and password assigned to the name.

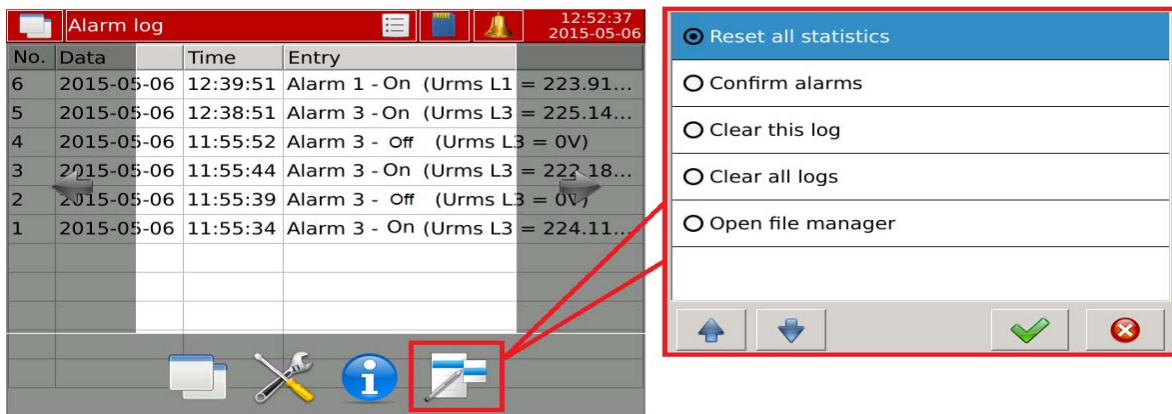

Fig. 160. Alarms - logs management.

Alarms logs are stored on the SD card. The file containing the current logs is saved as **alarm.log.csv**.

Preview a file stored on the SD card is shown below.

1	2016-01-28	13:33:28	Alarm 1 - On (Urms L1 1s = 227.121V) (> 200)
2	2016-01-28	13:33:28	Alarm 2 - On (Urms L2 200ms = 227.117V) (> 210)
3			

Fig. 161. Alarms - entries in log file.

Each file containing the alarms logs has a limited maximum size. After it is full another file **alarm.log.csv** is created and the previously saved file is changed to **alarm.log.1.csv** and when the entries in subsequent alarms logs are full **alarm.log.2.csv**, **alarm.log.3.csv** etc.

## 11. Construction

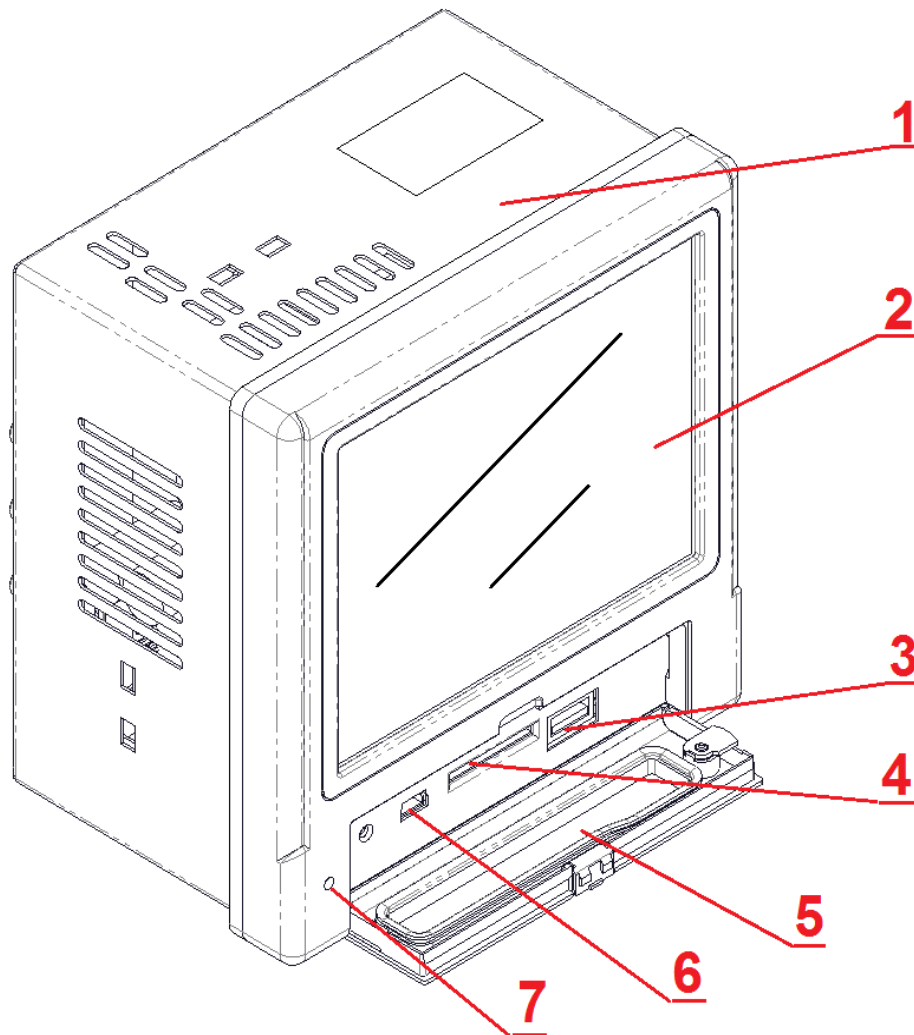

Fig. 162. Construction of ND45.

Item	Description
1	Casing of the analyzer.
2	LCD touch screen.
3	USB Host.
4	SD card socket.
5	Door with a lock.
6	USB Device.
7	LED diode.



## 11.1. Screen

Color LCD TFT screen 5,6-inch, resolution 640x480 pixels, with touch panel.

## 11.2. RS485 Interface

ND45 analyzer has RS-485 serial interface for communication in computer systems and with other Master devices. Asynchronous char communication protocol MODBUS has been implemented at the serial interface. The data transmission protocol describes methods of information exchange between the devices through the serial interface. The implemented protocol is in accordance with the standard PI-MBUS-300 Rev G of Modicon Company. In section 5.7. *Configuration of Modbus* we show the configuration of serial port settings.

Parameter	Description
Identifier	0xD8
The address of the meter	The values in the range from 1 to 247
Transmission speed	1200 bit/s, 2400 bit/s, 4800 bit/s, 9600 bit/s, 19200 bit/s, 38400 bit/s, 57600 bit/s, 115200 bit/s, 230400 bit/s.
Operating mode	Modbus RTU
Information unit	8N2, 8E1, 8O1, 8N1.
Maximum response time	600 ms
The maximum number of read registers	122 registers – 2-byte
Implemented functions	03, 04 - registers reading (common address space)
	17 – identification of the device

**Description of each function with examples is shown below.**

### Function 04 – readout of n-registers :

Readout of 4 registers 16-bytes of integer type, starting with the register addressed 00 01 of float type (2 x16 bits).

Request:

Address of the device	Function	Address of the register	Number of registers	Checksum CRC
01	04	00 01	00 04	20 0B

Response

Address of the device	Function	Number of bytes	Values of registers				Checksum CRC
			01	02	03	04	
01	04	08	00 0A	00 0B	00 63	00 64	DA 39

**Function 03 – readout of n-registers :**

Readout of 4 registers 16-bytes, starting with the register addressed 00 01.

Request:

Address of the device	Function	Address of the register	Number of registers	Checksum CRC
01	03	00 01	00 04	15 C9

Response :

Address of the device	Function	Number of bytes	Value from the register				Checksum CRC
			01	02	03	04	
01	04	08	70 A4	41 CD	00 00	41 A2	55 CB

**Function 17 – identification of the device :**

Request:

Address of the device	Function	Address of the register
01	11	C0 2C

Response :

Address of the device	Function	Number of bytes	Device ID	State of the device	Checksum CRC
01	11	02	D8	FF	A7 7C

### 11.3. Ethernet Interface

The analyzer of network parameters ND45 is equipped with the Ethernet interface for connecting the meter to a local or global network via the RJ45 socket. The implemented network services supported by the Ethernet interface: Web server, FTP server, Modbus Slave TCP/IP.

**Caution!** Detailed information on the configuration of the interface on the device is presented in section 5.6. *Configuration of Ethernet.*

In order to gain access to Ethernet services, the ND45 analyzer must be connected to the network via the RJ45 socket, located in the back of the casing, operating in accordance with TCP/IP protocol.

Description of RJ45 socket diodes function:

- Yellow LED - illuminates when ND45 is properly connected to the Ethernet network  
100 Base-T, does not light up when ND45 is not connected to the network or is connected to 10-Base-T network.
- green LED - Tx/Rx illuminates when the meter sends and receives data, flickers irregularly, when no data is transmitted the diode lights up permanently

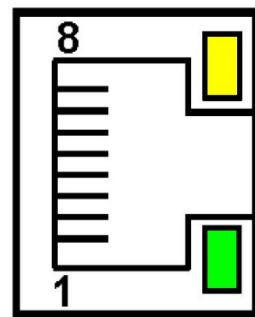

Fig. 163. Ethernet.

In order to connect ND45 to the network the User should use twisted pair cable.

- U/FTP – twisted pair cable with each pair foiled,
- F/FTP – twisted pair cable with each pair foiled, additionally cable with foil shield,
- S/FTP (formerly SFTP) – twisted pair cable with each pair foiled, additionally cable with wire mesh shield,
- SF/FTP (formerly S-STP) – twisted pair cable with each pair foiled, additionally with foil and wire mesh shield,

Conduct or no.	Signal	Conductor color acc. to standard	
		EIA/TIA 568A	EIA/TIA 568B
1	TX+	white-green	white-orange
2	TX-	green	orange
3	RX+	white-orange	white-green
4	EPWR+	blue	blue
5	EPWR+	white-blue	white-blue
6	RX-	orange	green
7	EPWR-	white-brown	white-brown
8	EPWR-	brown	brown

Categories of twisted pair cable according to the European standard EN 50171 minimum: Class D (category 5) - for high-speed local area networks, includes applications using the frequency band up to 100 MHz. For Ethernet interface the User should use twisted pair cable of STP type (shielded) category 5 with RJ-45 connector with conductors colors (in accordance with the colors described in the table) acc. to the following standard:

- EIA/TIA 568A for both connectors at the so-called simple connection of ND45 to the network hub or switch,
- EIA/TIA 568A the first connector and EIA/TIA 568B for the second connector at the so-called patch cord connection (crossover) used, among others, when connecting ND45 to the computer.

## 11.4. USB Interface

The analyzer has two USB interfaces. USB Host and USB Device.

Using the USB Host interface the User can copy files between the SD card and the device connected to the USB Host. USB Device acts as a dummy connector.

## 11.5. SD memory card

Standard data carrier in ND45 analyzer is SD card up to 32 GB.

The SD card is used for storage of archive data (depending on configuration), alarm logs, audit logs and logs of events related to dips, swells and interruptions.

All data files of archive data and logs first are first stored in the analyzer's internal memory (up to 20 MB). After saving the file in internal memory, it is transferred to the SD card.

If ND45 is operated without an SD card installed, all files (currently saved and those that have already been completed) are stored in the internal memory. After installing the card, all completed files will be transferred from the internal memory.

**Caution!** In case of power failure, up to 1 MB of data stored in the internal memory will be preserved.

Access to the SD card from ND45 is possible using the Web server (Chapter 3), FTP server (Chapter 4) or the incorporated file manager (Chapter 6).

## 12. Technical data

### 12.1. Measurements

Basic error with respect to the nominal value.

Measured value		Agreg.	Measurement range	Basic error		Remarks	
Symbol				Class A/S	Class S	Class A/S	Class S
<b>Voltage</b>							
RMS	Urms L1, Urms L2, Urms L3, Uavg L123.	200 ms	Un = U <sub>din</sub> = 230 V : 23,0...345,0 V (Ku = 1) ...1,38 MV (Ku ≠ 1) <sup>2</sup>	±0,2% U <sub>din</sub> <sup>1)</sup>		Class B	
		1 s		±0,2% U <sub>din</sub> <sup>1)</sup>		Class B	
		3 s	Un = U <sub>din</sub> = 57,7 V : 5,7...86,5 V (Ku = 1) ...280 kV (Ku ≠ 1) <sup>2</sup>	±0,1% U <sub>din</sub>	±0,2% U <sub>din</sub>	Class A <sup>1)</sup>	Class S
		10 min		±0,1% U <sub>din</sub>	±0,2% U <sub>din</sub>	Class A <sup>1)</sup>	Class S
		2 hours		±0,1% U <sub>din</sub>	±0,2% U <sub>din</sub>	Class A <sup>1)</sup>	Class S
Basic RMS	Ufund L1, Ufund L2, Ufund L3, Ufund L123.	200 ms	Un = U <sub>din</sub> = 230 V : 23,0...345,0 V (Ku = 1) ...1,38 MV (Ku ≠ 1) <sup>2</sup>	±0.2% U <sub>din</sub> <sup>1)</sup>			
		1 s					
		3 s					
		10 min					
		2 hour					
Phase-to-phase	Umf L1-2, Umf L2-3, Umf L3-1, Umf avg L123.	200 ms	Unmf = 400 V : 40,0...600,0 V (Ku = 1) ...2,4 MV (Ku ≠ 1) <sup>2</sup>	±0.5% Unmf			
		1 s					
		3 s					
		10 min					
		2 hour					
Asymmetry	Vunb.	200 ms	0.00...100.00%	±0.3%			
		1 s					
		3 s					
		10 min					
		2 hour					
Half wave	Uhalf1 L1 ... Uhalf24 L1, Uhalf1 L2 ... Uhalf24 L2,	200 ms	Un = U <sub>din</sub> = 230 V : 23,0...345,0 V (Ku = 1) ...1,38 MV (Ku ≠ 1) <sup>2</sup>			Class A	Class S

Harmonics	Uhalf1 L3 ... Uhalf24 L3.		$U_n = U_{din} = 57,7 \text{ V} :$ $5,7...70 \text{ V} (K_u = 1)$ $...280 \text{ kV} (K_u \neq 1)$	$\pm 0,2\%$ $U_{din}^{1)}$	$\pm 1\%$ $U_{din}^{1)}$		
	Har1 UL1 ... Har51 UL1, Har1 UL2 ... Har51 UL2, Har1 UL3 ... Har51 UL3.	1 s	0.00...100.00%	$U_m \geq 1\% U_{nom}$ $\pm 5\% U_m$ $U_m < 1\% U_{nom}$ $\pm 0.05\% U_{nom}$		Class I	
	Distortion factor	1 s	0.00...200.00%	$\pm 5\% ^7$			
	Harmonics groups distortion factor	1 s	0.00...200.00%	$\pm 5\%$			
	Harmonics sub-groups distortion factor	1 s	0.00...200.00%	$\pm 5\%$			
Partially weighted distortion factor	PWHD U L1, PWHD U L2, PWHD U L3, PWHD Uavg L123.	1 s	0.00...200.00%	$\pm 5\%$			
Demand	U Demand	15 min	$U_n = U_{din} = 230 \text{ V} :$ $23,0...345,0 \text{ V} (K_u = 1)$ $...1,38 \text{ MV} (K_u \neq 1)^2$ $U_n = U_{din} = 57,7 \text{ V} :$ $5,7...86,5 \text{ V} (K_u = 1)$ $...280 \text{ kV} (K_u \neq 1)^2$	$\pm 0.1\% U_{din}$			
		30 min					
		1 hour					
<b>Current</b>							
RMS	Irms L1, Irms L2, Irms L3, Iavg L123.	200 ms	$I_n = 5 \text{ A} :$	$\pm 0,2\% I_n$		Class B	
		1 s	$0,050...7,5 \text{ A} (K_i = 1)$ $...150,0 \text{ kA} (K_i \neq 1)^2$	$\pm 0,2\% I_n$		Class B	
		3 s	$I_n = 1 \text{ A} :$ $0,010...1,5 \text{ A} (K_i = 1)$	$\pm 0,1\%$ $I_n$	$\pm 0,2\%$ $I_n$	Class A	Class S
		10 min	$...30,0 \text{ kA} (K_i \neq 1)^2$	$\pm 0,1\%$ $I_n$	$\pm 0,2\%$ $I_n$	Class A <sup>1)</sup>	Class S

		2 hours		$\pm 0,1\%$ In	$\pm 0,2\%$ In	Class A <sup>1)</sup>	Class S
Neutral	IN	200 ms	In = 5 A :	$\pm 0,5\%$ In		Class S	
		1 s	0,050...7,5 A (Ki = 1) ...150,0 kA (Ki $\neq$ 1) <sup>2</sup>	$\pm 0,5\%$ In			
		3 s	In = 1 A :	$\pm 0,5\%$ In			
		10 min	0,010...1,5 A (Ki = 1) ...90,0 kA (Ki $\neq$ 1) <sup>2</sup>	$\pm 0,5\%$ In			
		2 hours		$\pm 0,5\%$ In			
Neutral countable	INC	200 ms	In = 5 A :	$\pm 0,2\%$ In			
		1 s	0,150...22,5 A (Ki = 1)				
		3 s	...450,0 kA (Ki $\neq$ 1) <sup>2</sup>				
		10 min	In = 1 A :				
		2 hours	0,030...4,5 A (Ki = 1) ...450,0 kA (Ki $\neq$ 1) <sup>2</sup>				
Harmonics	Har1 IL1 ... Har51 IL1, Har1 IL2 ... Har51 IL2, Har1 IL3 ... Har51 IL3.	1 s	0.00...100.00%	$I_m \geq 3\% I_{nom}$ $\pm 5\% I_m$ $I_m < 3\% I_{nom}$ $\pm 0.15\% I_{nom}$		Class I	
Interharmonics	IHar1 IL1 ... IHar51 IL1, IHar1 IL2 ... IHar51 IL2, IHar1 IL3 ... IHar51 IL3.	1 s	0.00...100.00%	$\pm 5\%^7$			
Distortion factor	THD I L1, THD I L2, THD I L3, THD Iavg L123.	1 s	0.00...200.00%	$\pm 5\%^7$			
Harmonics groups distortion factor	THDS I L1, THDS I L2, THDS I L3, THDS Iavg L123.	1 s	0.00...200.00%	$\pm 5\%^7$			
Harmonics sub-groups distortion factor	THDG I L1, THDG I L2, THDG I L3, THDG Iavg L123.	1 s	0.00...200.00%	$\pm 5\%^7$			
Partially weighted	PWHD I L1, PWHD I L2,	1 s	0.00...200.00%	$\pm 5\%^7$			

distortion factor	PWHD I L3, PWHD Iavg L123.				
Demand	I Demand	15 min	In = 5 A :	±0.2% In	
		30 min	0,050...7,5 A (Ki = 1)		
		1 hour	...150,0 kA (Ki ≠ 1)		
			In = 1 A :		
			0,010...1,5 A (Ki = 1)		
			...150,0 kA (Ki ≠ 1)		
<b>Power</b>					
Active imported power	EnP + L1, EnP + L2, EnP + L3, ΣEnP + L123.	-	L1, L2, L3 : 0...3e+3 Gwh L123: 0...9e+3 Gwh	±0.5% <sup>7</sup>	
Active exported power	EnP - L1, EnP - L2, EnP - L3, ΣEnP - L123.	-	L1, L2, L3 : 0...3e+3 Gwh L123: 0...9e+3 Gwh	±0.5% <sup>7</sup>	
Reactive imported energy	EnQ + L1, EnQ + L2, EnQ + L3, ΣEnQ + L123.	-	L1, L2, L3 : 0...3e+3 GVarh L123: 0...9e+3 GVarh	±0.5% <sup>7</sup>	
Reactive exported energy	EnQ - L1, EnQ - L2, EnQ - L3, ΣEnQ - L123.	-	L1, L2, L3 : 0...3e+3 GVarh L123: 0...9e+3 GVarh	±0.5% <sup>7</sup>	
Apparent energy	EnS L1, EnS L2, EnS L3, ΣEnS L123.	-	L1, L2, L3 : 0...3e+3 GVarh L123: 0...9e+3 GVarh	±0.5% <sup>7</sup>	
Active power	P L1, P L2, P L3, Pavg L123, ΣP L123.	200 ms	In = 5A, Un =230V: -2587,5...2587,5W (Ki=1,Ku=1)	±0.5% <sup>7</sup>	
		1 s			
		3 s	In = 1A, Un =230V: -517,3...517,3W (Ki=1,Ku=1)		
		10 min	In = 5A, Un =57,7V: -525...525W (Ki=1,Ku=1)		
		2 hours	In = 1A, Un =57,7V: -105...105 W (Ki=1,Ku=1)		
Reactive power	Q L1, Q L2, Q L3, Qavg L123, ΣQ L123.	200 ms	In = 5A, Un=230V: -2587,5...2587,5W (Ki=1,Ku=1)	±0.5% <sup>7</sup>	
		1 s			
		3 s	In = 1A, Un=230V: -517,3...517,3W (Ki=1,Ku=1)		
		10 min	In = 5A, Un =57,7V: -525...525W (Ki=1,Ku=1)		
		2 hours	In = 1A, Un =57,7V: -105...105 W (Ki=1,Ku=1)		



Apparent power	S L1, S L2, S L3, Savg L123, ΣS L123.	200 ms	In = 5A, Un=230V: 1,5...2587,5VA (Ki=1,Ku=1)	±0.5% <sup>7</sup>	
		1 s	In = 1A, Un=230V: 0,23...517,5VA (Ki=1,Ku=1)		
		3 s	In = 5A, Un =57,7V: 0,285...525W (Ki=1,Ku=1)		
		10 min	In = 1A, Un =57,7V: 0,057...105 W (Ki=1,Ku=1)		
		2 hours			
Demand	P Demand	15 min	In = 5A, Un=230V: -2587,5...2587,5W (Ki=1,Ku=1)	±0.5% <sup>7</sup>	
		30 min	In = 1A, Un=230V: -517,3...517,3W (Ki=1,Ku=1)		
		1 hour	In = 5A, Un =57,7V: -525...525W (Ki=1,Ku=1) In = 1A, Un =57,7V: -105...105 W (Ki=1,Ku=1)		
	Q Demand,	15 min	In = 5A, Un=230V: -2587,5...2587,5W (Ki=1,Ku=1)		
		30 min	In = 1A, Un=230V: -517,3...517,3W (Ki=1,Ku=1)		
		1 hour	In = 5A, Un =57,7V: -525...525W (Ki=1,Ku=1) In = 1A, Un =57,7V: -105...105 W (Ki=1,Ku=1)		
	S Demand	15 min	In = 5A, Un=230V: 1,5...2587,5VA (Ki=1,Ku=1)		
		30 min	In = 1A, Un=230V: 0,23...517,5VA (Ki=1,Ku=1)		
		1 hour	In = 5A, Un =57,7V: 0,285...525W (Ki=1,Ku=1) In = 1A, Un =57,7V: 0,057...105 W (Ki=1,Ku=1)		
	<b>Other</b>				
Frequency	f	1 s	For 50Hz 42.5 ... 57.5Hz	±0.05Hz	Class S
		10 s	For 60Hz 51 ... 69Hz	±0.05Hz	Class S
Flicker	Pst (U L1, U L2, U L3) Plt (U L1, U L2, U L3)	1 min	0.2...10.00	±0.5% <sup>7</sup>	
		10 min			
		2 hours			
Power distortion factor	dPF L1, dPF L2, dPF L3,	200 ms	0...1	±0.5% <sup>7</sup>	
		1 s			
		3 s			

	dPFavg L123.	10 min						
		2 hours						
Active power factor	PF L1, PF L2, PF L3, PFavg L123.	200 ms	-1...1	$\pm 0.5\%^7$				
		1 s						
		3 s						
		10 min						
		2 hours						
tgφ factor	tgφ L1, tgφ L2, tgφ L3, tgφavg L123.	200 ms	-10...10	$\pm 1\%^7$				
		1 s						
		3 s						
		10 min						
		2 hours						
Angle between the voltage and current	φ L1, φ L2, φ L3, φavg L123.	200 ms	-180°...180°	$\pm 0,5\%^7$				
		1 s						
		3 s						
		10 min						
		2 hours						
Voltage phase-to-phase angle	∠ U L1-2, ∠ U L2-3, ∠ U L3-1.	200 ms	Un = 230 V : 40,0...600,0 V (Ku = 1) ...2,39 MV (Ku ≠ 1) <sup>2</sup> Un = 100 V : 10,0...120,0 V (Ku = 1) ...480 kV (Ku ≠ 1) <sup>2</sup>	$\pm 0.5\%^7$				
		1 s						
		3 s						
		10 min						
		2 hours						
Temperature / Resistance	T1, T2	1s	Pt100: -200...850° Pt1000: -200...850° Resistance: 0...5000Ω	$\pm 0.2\%^7$				
Dip Swell Interrupt	Swell	f=50Hz 10ms <sup>2)</sup>	Un = U <sub>din</sub> = 230 V : 23,0...345,0 V (Ku = 1) ...1,38 MV (Ku ≠ 1) Un = 57,7 V : 5,7...86,5 V (Ku = 1) ...280 kV (Ku ≠ 1)	$\pm 0,2\%$ U <sub>din</sub> <sup>1)</sup>	$\pm 1\%$ U <sub>din</sub> <sup>1)</sup>	Class A	Class S	
	Dip	f=60Hz						
	Interrupt	8.3ms <sup>2)</sup>						

1. Basic error with respect to the U<sub>din</sub> value acc. to EN-61000-4-30.
2. Range Ku = 1 ... 4000.0 and Ki = 1 ... 20,000.0 .
3. U<sub>din</sub> - value obtained from the declared supply voltage U<sub>c</sub> = U<sub>n</sub> by the transformer ratio, according to PN-EN-61000-4-30.
4. I<sub>m</sub> , U<sub>m</sub> – measured values of currents and voltages according to EN-61000-4-7.
5. I<sub>nom</sub> , U<sub>nom</sub> – nominal values of currents and voltages according to EN-61000-4-7.
6. I<sub>n</sub> , U<sub>n</sub> – nominal values of currents and voltages according to EN-61000-4-30.
7. Basic error iwith respect to the full measurement range.

## 12.2. Extension cards

Availability of inputs/outputs depends on the ordered version of the analyzer.

### 12.2.1 Analog outputs

<b>Type:</b>	3 galvanically isolated current outputs
<b>Output signal:</b>	0/4...20 mA
<b>Output basic error:</b>	0.5 %
<b>Load resistance:</b>	$\leq 500 \Omega$
<b>Isolation:</b>	500 V dc
<b>Response time:</b>	200 ms

### 12.2.2 6 galvanically isolated binary inputs

<b>Type:</b>	6 galvanically isolated current outputs
<b>Output signal:</b>	0/4...20 mA
<b>Output basic error:</b>	$\pm 0.1$ % of measuring range
<b>Load resistance:</b>	$\leq 500 \Omega$
<b>Isolation:</b>	500 V dc
<b>Response time:</b>	200 ms

### 12.2.3 Binary inputs

<b>Type:</b>	2 groups of 3 digital inputs with common ground
<b>Control signal:</b>	0/5...24 V dc
<b>Switching frequency:</b>	Up to 4 Hz input voltage from range +5...24 V dc Up to 500 Hz input voltage from range +8...24 V dc
<b>Isolation:</b>	500 V dc

### 12.2.4. Alarm outputs

<b>Type:</b>	8 or 4 programmable electromagnetic relays, normally open (NO)
<b>Voltage of contacts / current of load:</b>	$\leq 250$ V ac / 1.5 A
	$\leq 30$ V dc / 1 A
<b>Output basic error:</b>	200 ms + hysteresis time

### 12.3. Reference conditions and rated operating conditions

<b>Storage conditions (temperature and humidity)</b>	Temperature : -20...50°C (-4...122°F) Humidity : below 75% RH (without condensation)
<b>Operating conditions (temperature and humidity)</b>	Temperature : 0...50°C (32...122°F) Humidity : 75% RH (without condensation)
<b>Power supply</b>	85...253 V ac, 40...400Hz 90...300 V dc
<b>Maximum power consumption in the circuit</b>	supply $\leq 20$ VA voltage $\leq 0.2$ VA current $\leq 0.2$ VA
<b>Acceptable crest factor</b>	Current measurement: 2 Voltage measurement: 2
<b>Resistance to dust and water</b>	IP54 – from the front side IP20 – from the terminal side

### 12.4. Operating safety according to EN 61010-1, basic insulation

<b>Installation category</b>	III
<b>Degree of pollution</b>	2
<b>Insulation voltage relative to earth</b>	RS485: 500V ac/dc Ethernet : 250V ac / 500V dc Temperature measurement input: 500V ac/dc Voltage input: 2140 V ac/dc Power and relay outputs circuits: 2140 V ac/dc Analog outputs: 500V ac/dc Binary inputs: 1200V ac/dc
<b>Maximum operating voltage relative to earth</b>	For power and relay outputs circuits: 300 V For measurement input: 500 V For RS485 circuits, Ethernet, relay outputs, analog outputs and binary inputs: 50 V
<b>Height above the sea level</b>	< 2000 m

## 12.5. Electromagnetic compatibility

<b>Electromagnetic emissions</b>	conforms EN 61000-6-4
<b>Interference immunity</b>	conforms EN 61000-6-2

## 12.6. Assembly

<b>Dimensions</b>	144 Width × 144 Height × 90 Depth mm (5.669" Width × 5.669" Height × 3,897" Depth)
<b>Dimensions of mounting hole</b>	138 <sup>-0,5</sup> Width x 138 <sup>-0,5</sup> Height mm (5.433 <sup>-0,02</sup> " Width × 5.433 <sup>-0,02</sup> " Height )
<b>Weight</b>	1.6 kg (5.44 oz.)

## 12.7. Conformity with standards

<b>EN 61010</b>	Operational safety
<b>EN 61000-6-4</b> <b>EN 61000-6-2</b>	Electromagnetic compatibility
<b>EN 50160</b> <b>EN 61000-4-30</b> <b>EN 61000-4-7</b> <b>EN 61557</b>	Measurements and parameters recounting

## 12.8. Tables of registers

In ND45 analyzer data is placed in 16 and 32-bit registers. Bits in 16-bit registers are numbered from the youngest to the oldest (b0 ... b15). 32-bit registers (4 bytes, 2 x 16 bits) contain float registers with bytes placed as follows: B4 B3 B2 B1.

In case of exceeding (the measured value is beyond the measuring range), the value 2e20 is entered.

**Caution!** All given addresses are physical addresses. In some computer programs, logical addressing is applied, then addresses must be increased by 1.

The map pf ND45 registers is presented below.

Address range	Register type	Description
0000 - 0013	Integer (16 bytes)	Information and status registers
0050 - 0170		Parameters measured with aggregation of 200 ms.
0200 - 0320		Parameters measured with aggregation of 1 s.

0350 - 0470	Float (2 x 16 bytes)	Parameters measured with aggregation of 3 s.
0500 - 0620		Parameters measured with aggregation of 10 min.
0650 - 0770		Parameters measured with aggregation of 2 h.
0800 - 0808		Parameters averaged in time (Demand).
0828 - 0844		Fliker
0818 - 0826		Frequency, temperature/resistance.
0852 - 0862		Statuses of binary inputs.
0900 - 1008		Energy meters.
1050 - 1112		Factors THD, THDG, THDS, PWHD.
1150 - 1760		Harmonics.
1762 - 2372		Interharmonics.
2380 - 2522		Half wave voltages.
2580 - 2799		Integer (16 bytes)
2800 - 2822	Float (2 x 16 bytes)	Pulse counters.
2850 - 3296		Tarifs.

### 12.8.1. Information and status registers

Register	Parameter	3Ph / 4W	3Ph / 3W
0000	Device ID	✓	✓
0001	Version of the main program	✓	✓
0002	Version of the measurement card program	✓	✓
0003	Status 1	✓	✓
0004	Status 2	✓	✓
0005	Status 3	✓	✓
0006	Time: seconds	✓	✓
0007	Time: hours and minutes (hour * 100 + minutes)	✓	✓
0008	Date: month and day (month * 100 + day)	✓	✓
0009	Date: year	✓	✓
0010	Serial number	✓	✓
0011	Serial number	✓	✓
0012	Password confirming the invocation of the CMD command	✓	✓
0013	CMD command assignment number	✓	✓

## 12.8.2. CMD commands

To execute the command, the correct security password must be set in register 12.

Command	Description
Resetting energy counters	
1	Active imported energy L1
2	Active imported energy L2
3	Active imported energy L3
4	Active imported energy L123
5	Active exported energy L1
6	Active exported energy L2
7	Active exported energy L3
8	Active exported energy L123
9	Active imported & exported energy L123
11	Reactive imported inductive energy L1
12	Reactive imported inductive energy L2
13	Reactive imported inductive energy L3
14	Reactive imported inductive energy L123
15	Reactive exported inductive energy L1
16	Reactive exported inductive energy L2
17	Reactive exported inductive energy L3
18	Reactive exported inductive energy L123
19	Reactive imported & exported inductive energy L123
21	Reactive imported capacitive energy L1
22	Reactive imported capacitive energy L2
23	Reactive imported capacitive energy L3
24	Reactive imported capacitive energy L123
25	Reactive exported capacitive energy L1
26	Reactive exported capacitive energy L2
27	Reactive exported capacitive energy L3
28	Reactive exported capacitive energy L123
29	Reactive imported & exported capacitive energy L123
31	Apparent energy L1
32	Apparent energy L2
33	Apparent energy L3
34	Apparent energy L123

39	Resetting all counters
----	------------------------

### 12.8.3. Status registers

#### Status 1

Bit no.	Description
0	No synchronization
1	Phase connection sequence error
2	Filled queue of measurement card
3	Calibration parameters error

#### Status 2

Bit no.	Description
0	Lower overrun UL1
1	Upper overrun UL1
2	Lower overrun UL2
3	Upper overrun UL2
4	Lower overrun UL3
5	Upper overrun UL3

#### Status 3

Bit no.	Description
0	Lower overrun IL1
1	Upper overrun IL1
2	Lower overrun IL2
3	Upper overrun IL2
4	Lower overrun IL3
5	Upper overrun IL3



### 12.8.4. Parameters measured with aggregation of 200 ms

Register	Parameter		Symbol		Unit	3Ph/ 4W	3Ph/ 3W
0050	Voltage RMS	L1	Urms	L1	V	✓	×
0052	Current RMS		Irms		A	✓	✓
0054	Primary voltage		Ufund		V	✓	×
0056	Active power		P		W	✓	×
0058	Reactive power		Q		var	✓	×
0060	Apparent power		S		VA	✓	×
0062	Power distortion factor		dPF		-	✓	×
0064	Active power factor		PF		-	✓	×
0066	tgφ factor		tgφ		-	✓	×
0068	Reserved						
0070	Angle between the voltage and current	L1	φ	L1	rad	✓	×
0072	Angle between the voltage and current		φ		°	✓	×
0074	Voltage RMS	L2	Urms	L2	V	✓	×
0076	Current RMS		Irms		A	✓	✓
0078	Primary voltage		Ufund		V	✓	×
0080	Active power		P		W	✓	×
0082	Reactive power		Q		var	✓	×
0084	Apparent power		S		VA	✓	×
0086	Power distortion factor		dPF		-	✓	×
0088	Active power factor		PF		-	✓	×
0090	tgφ factor		tgφ		-	✓	×
0092	Reserved						
0094	Angle between the voltage and current	L2	φ	L2	rad	✓	×
0096			φ		°	✓	×
0098	Voltage RMS	L3	Urms	L3	V	✓	×
0100	Current RMS		Irms		A	✓	✓
0102	Primary voltage		Ufund		V	✓	×
0104	Active power		P		W	✓	×
0106	Reactive power		Q		var	✓	×
0108	Apparent power		S		VA	✓	×
0110	Power distortion factor		dPF		-	✓	×
0112	Active power factor		PF		-	✓	×
0114	tgφ factor		tgφ		-	✓	×

0116	Reserved						
0118	Angle between the voltage and current	L3	$\phi$	L3	rad	✓	✗
0120			$\phi$		°	✓	✗
0122	Average voltage	L123	Uavg	L123	V	✓	✗
0124	Average current		I avg		A	✓	✗
0126	Average primary voltage		Ufavg		V	✓	✗
0128	Active power sum		$\Sigma P$		W	✓	✓
0130	Sum of reactive power		$\Sigma Q$		var	✓	✓
0132	Sum of apparent power		$\Sigma S$		VA	✓	✓
0134	Average value of power distortion factor		dPFavg		-	✓	✗
0136	Average value of active power factor		PFavg		-	✓	✓
0138	Average value of $\text{tg}\phi$ factor	tg $\phi$ avg	-	✓	✗		
0140	Phase-to-phase voltage L1-2	Umf L1-2		V	✓	✓	
0142	Phase-to-phase voltage L2-3	Umf L2-3		V	✓	✓	
0144	Phase-to-phase voltage L3-1	Umf L3-1		V	✓	✓	
0146	Average phase-to-phase voltage	L123	Umf avg	L123	V	✓	✓
0148	Average active power		Pavg		W	✓	✗
0150	Average reactive power		Qavg		var	✓	✗
0152	Average apparent power		Savg		VA	✓	✗
0154	Current in neutral wire	IN		A	✓	✗	
0156	Recalculated current in neutral wire	INC		A	✓	✗	
0158	Average value of angle between voltage and current	L123	$\phi$ avg	L123	rad	✓	✗
0160			$\phi$ avg		°	✓	✗
0162	Voltage phase-to-phase angle L1-2	$\sphericalangle$ U L1-2		°	✓	✓	
0164	Voltage phase-to-phase angle L2-3	$\sphericalangle$ U L2-3		°	✓	✓	
0166	Voltage phase-to-phase angle L3-1	$\sphericalangle$ U L3-1		°	✓	✓	
0168	Average value of phase-to-phase angle	$\sphericalangle$ U avg L123		°	✓	✓	
0170	Voltage asymmetry	Vunb		%	✓	✓	

4300	Voltage RMS - MAX	Urms	L1	V	✓	✗
4302	Voltage RMS - MIN	Urms		V	✓	✗
4304	Current RMS - MAX	Irms		A	✓	✓
4306	Current RMS - MIN	Irms		A	✓	✓
4308	Primary voltage - MAX	Ufund		V	✓	✗
4310	Primary voltage - MIN	Ufund		V	✓	✗
4312	Active power - MAX	P		W	✓	✗

4314	Active power - MIN	P		W	✓	✗
4316	Reactive power - MAX	Q		var	✓	✗
4318	Reactive power - MIN	Q		var	✓	✗
4320	Apparent power - MAX	S		VA	✓	✗
4322	Apparent power - MIN	S		VA	✓	✗
4324	Voltage RMS - MAX	Urms		V	✓	✗
4326	Voltage RMS - MIN	Urms		V	✓	✗
4328	Current RMS - MAX	Irms		A	✓	✓
4330	Current RMS - MIN	Irms		A	✓	✓
4332	Primary voltage - MAX	Ufund		V	✓	✗
4334	Primary voltage - MIN	Ufund		V	✓	✗
4336	Active power - MAX	P		W	✓	✗
4338	Active power - MIN	P		W	✓	✗
4340	Reactive power - MAX	Q		var	✓	✗
4342	Reactive power - MIN	Q		var	✓	✗
4344	Apparent power - MAX	S		VA	✓	✗
4346	Apparent power - MIN	S	VA	✓	✗	

4348	Voltage RMS - MAX	Urms	L3	V	✓	✗
4350	Voltage RMS - MIN	Urms		V	✓	✗
4352	Current RMS - MAX	Irms		A	✓	✓
4354	Current RMS - MIN	Irms		A	✓	✓
4356	Primary voltage - MAX	Ufund		V	✓	✗
4358	Primary voltage - MIN	Ufund		V	✓	✗
4360	Active power - MAX	P		W	✓	✗
4362	Active power - MIN	P		W	✓	✗
4364	Reactive power - MAX	Q		var	✓	✗
4366	Reactive power - MIN	Q		var	✓	✗
4368	Apparent power - MAX	S		VA	✓	✗
4370	Apparent power - MIN	S		VA	✓	✗

## 12.8.5. Parameters measured with aggregation of 1 s

Register	Parameter		Symbol		Unit	3Ph/ 4W	3Ph/ 3W
0200	Voltage RMS		Urms		V	✓	×
0202	Current RMS		Irms		A	✓	✓
0204	Primary voltage		Ufund		V	✓	×
0206	Active power	L1	P	L1	W	✓	×
0208	Reactive power		Q		var	✓	×
0210	Apparent power		S		VA	✓	×
0212	Power distortion factor		dPF		-	✓	×
0214	Active power factor		PF		-	✓	×
0216	tgφ factor		tgφ		-	✓	×
0218	Reserved						
0220	Angle between the voltage and current	L1	φ	L1	rad	✓	×
0222			φ		°	✓	×
0224	Voltage RMS	L2	Urms	L2	V	✓	×
0226	Current RMS		Irms		A	✓	✓
0228	Primary voltage		Ufund		V	✓	×
0230	Active power		P		W	✓	×
0232	Reactive power		Q		var	✓	×
0234	Apparent power		S		VA	✓	×
0236	Power distortion factor		dPF		-	✓	×
0238	Active power factor		PF		-	✓	×
0240	tgφ factor		tgφ		-	✓	×
0242	Reserved						
0244	Angle between the voltage and current	L2	φ	L2	rad	✓	×
0246			φ		°	✓	×
0248	Voltage RMS	L3	Urms	L3	V	✓	×
0250	Current RMS		Irms		A	✓	
0252	Primary voltage		Ufund		V	✓	×
0254	Active power		P		W	✓	×
0256	Reactive power		Q		var	✓	×
0258	Apparent power		S		VA	✓	×
0260	Power distortion factor		dPF		-	✓	×
0262	Active power factor		PF		-	✓	×
0264	tgφ factor		tgφ		-	✓	×

0266		Reserved					
0268	Angle between the voltage and current	L3	$\varphi$	L3	rad	✓	×
0270			$\varphi$			°	✓
0272	Average voltage	L123	Uavg	L123	V	✓	×
0274	Average current		I avg		A	✓	✓
0276	Average primary voltage		Ufavg		V	✓	×
0278	Sum of active power		$\Sigma P$		W	✓	×
0280	Sum of reactive power		$\Sigma Q$		var	✓	×
0282	Sum of apparent power		$\Sigma S$		VA	✓	×
0284	Average value of power distortion factor		dPFavg		-	✓	×
0286	Average value of active power factor	PFavg	-	✓	×		
0288	Average value of tg $\varphi$ factor	tg $\varphi$ avg	-	✓	×		
0290	Phase-to-phase voltage L1-2	L123	Umf L1-2	L123	V	✓	✓
0292	Phase-to-phase voltage L2-3		Umf L2-3		V	✓	✓
0294	Phase-to-phase voltage L3-1		Umf L3-1		V	✓	✓
0296	Average phase-to-phase voltage		Umf avg			✓	
0298	Average active power		Pavg		W	✓	×
0300	Average reactive power		Qavg		var	✓	×
0302	Average apparent power		Savg		VA	✓	×
0304	Current in neutral wire	IN	A	✓	×		
0306	Recalculated current in neutral wire	INC	A	✓	×		
0308	Average value of angle between voltage and current	L123	$\varphi$ avg	L123	rad	✓	×
0310			$\varphi$ avg			°	✓
0312	Voltage phase-to-phase angle L1-2		$\sphericalangle$ U L1-2		°	✓	✓
0314	Voltage phase-to-phase angle L2-3		$\sphericalangle$ U L2-3		°	✓	✓
0316	Voltage phase-to-phase angle L3-1		$\sphericalangle$ U L3-1		°	✓	✓
0318	Average value of phase-to-phase angle		$\sphericalangle$ U avg L123		°	✓	✓
0320	Voltage asymmetry	Vunb	%	✓	✓		

4400	Voltage RMS - MAX	Urms	L1	V	✓	×
4402	Voltage RMS - MIN	Urms		V	✓	×
4404	Current RMS - MAX	Irms		A	✓	✓
4406	Current RMS - MIN	Irms		A	✓	✓
4408	Primary voltage - MAX	Ufund		V	✓	×
4410	Primary voltage - MIN	Ufund		V	✓	×

4412	Active power - MAX	P	W	✓	✗
4414	Active power - MIN	P	W	✓	✗
4416	Reactive power - MAX	Q	var	✓	✗
4418	Reactive power - MIN	Q	var	✓	✗
4420	Apparent power - MAX	S	VA	✓	✗
4322	Apparent power - MIN	S	VA	✓	✗
4424	Voltage RMS - MAX	Urms	V	✓	✗
4426	Voltage RMS - MIN	Urms	V	✓	✗
4428	Current RMS - MAX	Irms	A	✓	✓
4430	Current RMS - MIN	Irms	A	✓	✓
4432	Primary voltage - MAX	Ufund	V	✓	✗
4434	Primary voltage - MIN	Ufund	V	✓	✗
4436	Active power - MAX	P	W	✓	✗
4438	Active power - MIN	P	W	✓	✗
4440	Reactive power - MAX	Q	var	✓	✗
4442	Reactive power - MIN	Q	var	✓	✗
4444	Apparent power - MAX	S	VA	✓	✗
4346	Apparent power - MIN	S	VA	✓	✗
4448	Voltage RMS - MAX	Urms	V	✓	✗
4450	Voltage RMS - MIN	Urms	V	✓	✗
4452	Current RMS - MAX	Irms	A	✓	✓
4454	Current RMS - MIN	Irms	A	✓	✓
4456	Primary voltage - MAX	Ufund	V	✓	✗
4458	Primary voltage - MIN	Ufund	V	✓	✗
4460	Active power - MAX	P	W	✓	✗
4462	Active power - MIN	P	W	✓	✗
4464	Reactive power - MAX	Q	var	✓	✗
4466	Reactive power - MIN	Q	var	✓	✗
4468	Apparent power - MAX	S	VA	✓	✗
4370	Apparent power - MIN	S	VA	✓	✗

## 12.8.6. Parameters measured with aggregation of 3 s

Register	Parameter		Symbol		Unit	3Ph/ 4W	3Ph / 3W
0350	Voltage RMS	L1	Urms	L1	V	✓	×
0352	Current RMS		Irms		A	✓	✓
0354	Primary voltage		Ufund		V	✓	×
0356	Active power		P		W	✓	×
0358	Reactive power		Q		var	✓	×
0360	Apparent power		S		VA	✓	×
0362	Power distortion factor		dPF		-	✓	×
0364	Active power factor		PF		-	✓	×
0366	tgφ factor		tgφ		-	✓	×
0368	Reserved						
0370	Angle between the voltage and current	L1	φ	L1	rad	✓	×
0372			φ		°	✓	×
0374	Voltage RMS	L2	Urms	L2	V	✓	×
0376	Current RMS		Irms		A	✓	✓
0378	Primary voltage		Ufund		V	✓	×
0380	Active power		P		W	✓	×
0382	Reactive power		Q		var	✓	×
0384	Apparent power		S		VA	✓	×
0386	Power distortion factor		dPF		-	✓	×
0388	Active power factor		PF		-	✓	×
0390	tgφ factor		tgφ		-	✓	×
0392	Reserved						
0394	Angle between the voltage and current	L2	φ	L2	rad	✓	×
0396			φ		°	✓	×
0398	Voltage RMS	L3	Urms	L3	V	✓	×
0400	Current RMS		Irms		A	✓	✓
0402	Primary voltage		Ufund		V	✓	×
0404	Active power		P		W	✓	×
0406	Reactive power		Q		var	✓	×
0408	Apparent power		S		VA	✓	×
0410	Power distortion factor		dPF		-	✓	×
0412	Active power factor		PF		-	✓	×
0414	tgφ factor		tgφ		-	✓	×

0416		Reserved					
0418	Angle between the voltage and current	L3	$\phi$	L3	rad	✓	✗
0420			$\phi$		°	✓	✗
0422	Average voltage		Uavg		V	✓	✗
0424	Average current		I avg		A	✓	✓
0426	Average primary voltage		Ufavg		V	✓	✗
0428	Sum of active power	L123	$\Sigma P$	L123	W	✓	✗
0430	Sum of reactive power		$\Sigma Q$		var	✓	✗
0432	Sum of apparent power		$\Sigma S$		VA	✓	✗
0434	Average value of power distortion factor		dPFavg		-	✓	✗
0436	Average value of active power factor		PFavg		-	✓	✗
0438	Average value of $\text{tg}\phi$ factor		$\text{tg}\phi$ avg		-	✓	✗
0440	Phase-to-phase voltage L1-2		Umf L1-2		V	✓	✓
0442	Phase-to-phase voltage L2-3		Umf L2-3		V	✓	✓
0444	Phase-to-phase voltage L3-1		Umf L3-1		V	✓	✓
0446	Average phase-to-phase voltage		Umf avg		V	✓	✓
0448	Average active power	L123	Pavg	L123	W	✓	✗
0450	Average reactive power		Qavg		var	✓	✗
0452	Average apparent power		Savg		VA	✓	✗
0454	Current in neutral wire		IN		A	✓	✗
0456	Recalculated current in neutral wire		INC		A	✓	✗
0458	Average value of angle between voltage and current	L123	$\phi$ avg	L123	rad	✓	✗
0460			$\phi$ avg		°	✓	✗
0462	Voltage phase-to-phase angle L1-2		$\sphericalangle$ U L1-2		°	✓	✓
0464	Voltage phase-to-phase angle L2-3		$\sphericalangle$ U L2-3		°	✓	✓
0466	Voltage phase-to-phase angle L3-1		$\sphericalangle$ U L3-1		°	✓	✓
0468	Average value of phase-to-phase angle L123		$\sphericalangle$ U avg L123		°	✓	✓
0470	Voltage asymmetry		Vunb		%	✓	✓

4500	Voltage RMS - MAX	Urms	L1	V	✓	✗
4502	Voltage RMS - MIN	Urms		V	✓	✗
4504	Current RMS - MAX	Irms		A	✓	✓
4506	Current RMS - MIN	Irms		A	✓	✓
4508	Primary voltage - MAX	Ufund		V	✓	✗
4510	Primary voltage - MIN	Ufund		V	✓	✗



4512	Active power - MAX	P	W	✓	✗
4514	Active power - MIN	P	W	✓	✗
4516	Reactive power - MAX	Q	var	✓	✗
4518	Reactive power - MIN	Q	var	✓	✗
4520	Apparent power - MAX	S	VA	✓	✗
4322	Apparent power - MIN	S	VA	✓	✗
4524	Voltage RMS - MAX	Urms	V	✓	✗
4526	Voltage RMS - MIN	Urms	V	✓	✗
4528	Current RMS - MAX	Irms	A	✓	✓
4530	Current RMS - MIN	Irms	A	✓	✓
4532	Primary voltage - MAX	Ufund	V	✓	✗
4534	Primary voltage - MIN	Ufund	V	✓	✗
4536	Active power - MAX	P	W	✓	✗
4538	Active power - MIN	P	W	✓	✗
4540	Reactive power - MAX	Q	var	✓	✗
4542	Reactive power - MIN	Q	var	✓	✗
4544	Apparent power - MAX	S	VA	✓	✗
4346	Apparent power - MIN	S	VA	✓	✗
4548	Voltage RMS - MAX	Urms	V	✓	✗
4550	Voltage RMS - MIN	Urms	V	✓	✗
4552	Current RMS - MAX	Irms	A	✓	✓
4554	Current RMS - MIN	Irms	A	✓	✓
4556	Primary voltage - MAX	Ufund	V	✓	✗
4558	Primary voltage - MIN	Ufund	V	✓	✗
4560	Active power - MAX	P	W	✓	✗
4562	Active power - MIN	P	W	✓	✗
4564	Reactive power - MAX	Q	var	✓	✗
4566	Reactive power - MIN	Q	var	✓	✗
4568	Apparent power - MAX	S	VA	✓	✗
4370	Apparent power - MIN	S	VA	✓	✗

### 12.8.6. Parameters measured with aggregation of 10 min

Register	Parameter		Symbol		Unit	3Ph / 4W	3Ph / 3W
0500	Voltage RMS	L1	Urms	L1	V	✓	✗
0502	Current RMS		Irms		A	✓	✓
0504	Primary voltage		Ufund		V	✓	✗
0506	Active power		P		W	✓	✗
0508	Reactive power		Q		var	✓	✗
0510	Apparent power		S		VA	✓	✗
0512	Power distortion factor		dPF		-	✓	✗
0514	Active power factor		PF		-	✓	✗
0516	tgφ factor		tgφ		-	✓	✗
0518	Reserved						
0520	Angle between the voltage and current		φ		rad	✓	✗
0522			φ		°	✓	✗
0524	Voltage RMS	L2	Urms	L2	V	✓	✗
0526	Current RMS		Irms		A	✓	✓
0528	Primary voltage		Ufund		V	✓	✗
0530	Active power		P		W	✓	✗
0532	Reactive power		Q		var	✓	✗
0534	Apparent power		S		VA	✓	✗
0536	Power distortion factor		dPF		-	✓	✗
0538	Active power factor		PF		-	✓	✗
0540	tgφ factor		tgφ		-	✓	✗
0542	Reserved						
0544	Angle between the voltage and current	L2	φ	L2	rad	✓	✗
0546			φ		°	✓	✗
0548	Voltage RMS	L3	Urms	L3	V	✓	✗
0550	Current RMS		Irms		A	✓	✓
0552	Primary voltage		Ufund		V	✓	✗
0554	Active power		P		W	✓	✗
0556	Reactive power		Q		var	✓	✗
0558	Apparent power		S		VA	✓	✗
0560	Power distortion factor		dPF		-	✓	✗
0562	Active power factor		PF		-	✓	✗
0564	tgφ factor		tgφ		-	✓	✗
0566	Reserved						
0568	Angle between the voltage and current	L3	φ	L3	rad	✓	✗

0570			$\phi$		$^{\circ}$	✓	✗
0572	Average voltage	L123	Uavg	L123	V	✓	✗
0574	Average current		I avg		A	✓	✓
0576	Average primary voltage		Ufavg		V	✓	✗
0578	Sum of active power		$\Sigma P$		W	✓	✗
0580	Sum of reactive power		$\Sigma Q$		var	✓	✗
0582	Sum of apparent power		$\Sigma S$		VA	✓	✗
0584	Average value of power distortion factor		dPFavg		-	✓	✗
0586	Average value of active power factor		PFavg		-	✓	✗
0588	Average value of $\text{tg}\phi$ factor		$\text{tg}\phi$ avg		-	✓	✗
0590	Phase-to-phase voltage L1-2	Umf L1-2		V	✓	✓	
0592	Phase-to-phase voltage L2-3	Umf L2-3		V	✓	✓	
0594	Phase-to-phase voltage L3-1	Umf L3-1		V	✓	✓	
0596	Average phase-to-phase voltage	L123	Umf avg	L123	V	✓	✓
0598	Average active power		Pavg		W	✓	✗
0600	Average reactive power		Qavg		var	✓	✗
0602	Average apparent power		Savg		VA	✓	✗
0604	Current in neutral wire	IN		A	✓	✗	
0606	Recalculated current in neutral wire	INC		A	✓	✗	
0608	Average value of angle between voltage and current	L123	$\phi$ avg	L123	rad	✓	✗
0610			$\phi$ avg		$^{\circ}$	✓	✗
0612	Voltage phase-to-phase angle L1-2	$\sphericalangle$ U L1-2		$^{\circ}$	✓	✓	
0614	Voltage phase-to-phase angle L2-3	$\sphericalangle$ U L2-3		$^{\circ}$	✓	✓	
0616	Voltage phase-to-phase angle L3-1	$\sphericalangle$ U L3-1		$^{\circ}$	✓	✓	
0618	Average value of phase-to-phase angle	$\sphericalangle$ U avg L123		$^{\circ}$	✓	✓	
0620	Voltage asymmetry	Vunb		%	✓	✓	
4600	Voltage RMS - MAX	Urms		L1	V	✓	✗
4602	Voltage RMS - MIN	Urms			V	✓	✗
4604	Current RMS - MAX	Irms			A	✓	✓
4606	Current RMS - MIN	Irms			A	✓	✓
4608	Primary voltage - MAX	Ufund			V	✓	✗
4610	Primary voltage - MIN	Ufund			V	✓	✗
4612	Active power - MAX	P			W	✓	✗
4614	Active power - MIN	P			W	✓	✗
4616	Reactive power - MAX	Q			var	✓	✗
4618	Reactive power - MIN	Q			var	✓	✗
4620	Apparent power - MAX	S			VA	✓	✗

4322	Apparent power - MIN	S		VA	✓	✗
4624	Voltage RMS - MAX	Urms		V	✓	✗
4626	Voltage RMS - MIN	Urms		V	✓	✗
4628	Current RMS - MAX	Irms		A	✓	✓
4630	Current RMS - MIN	Irms		A	✓	✓
4632	Primary voltage - MAX	Ufund		V	✓	✗
4634	Primary voltage - MIN	Ufund		V	✓	✗
4636	Active power - MAX	P		W	✓	✗
4638	Active power - MIN	P		W	✓	✗
4640	Reactive power - MAX	Q		var	✓	✗
4642	Reactive power - MIN	Q		var	✓	✗
4644	Apparent power - MAX	S		VA	✓	✗
4346	Apparent power - MIN	S		VA	✓	✗
4648	Voltage RMS - MAX	Urms		V	✓	✗
4650	Voltage RMS - MIN	Urms		V	✓	✗
4652	Current RMS - MAX	Irms		A	✓	✓
4654	Current RMS - MIN	Irms		A	✓	✓
4656	Primary voltage - MAX	Ufund		V	✓	✗
4658	Primary voltage - MIN	Ufund		V	✓	✗
4660	Active power - MAX	P		W	✓	✗
4662	Active power - MIN	P		W	✓	✗
4664	Reactive power - MAX	Q		var	✓	✗
4666	Reactive power - MIN	Q		var	✓	✗
4668	Apparent power - MAX	S		VA	✓	✗
4370	Apparent power - MIN	S		VA	✓	✗

**12.8.8. Parameters measured with aggregation of 2 hours**

Register	Parameter	Symbol	Unit	3Ph/ 4W	3Ph/ 3W
0650	Voltage RMS	Urms	V	✓	✗
0652	Current RMS	Irms	A	✓	✓
0654	Primary voltage	Ufund	V	✓	✗
0656	Active power	P	W	✓	✗
0658	Reactive power	Q	var	✓	✗
0660	Apparent power	S	VA	✓	✗

0662	Power distortion factor		dPF		-	✓	×
0664	Active power factor		PF		-	✓	×
0666	tgφ factor		tgφ		-	✓	×
0668	Reserved						
0670	Angle between the voltage and current	L1	φ	L1	rad	✓	×
0672			φ		°	✓	×
0674	Voltage RMS		Urms		V	✓	×
0676	Current RMS		Irms		A	✓	✓
0678	Primary voltage		Ufund		V	✓	×
0680	Active power		P		W	✓	×
0682	Reactive power	L2	Q	L2	var	✓	×
0684	Apparent power		S		VA	✓	×
0686	Power distortion factor		dPF		-	✓	×
0688	Active power factor		PF		-	✓	×
0690	tgφ factor		tgφ		-	✓	×
0692	Reserved						
0694	Angle between the voltage and current	L2	φ	L2	rad	✓	×
0696			φ		°	✓	×
0698	Voltage RMS		Urms		V	✓	×
0700	Current RMS		Irms		A	✓	×
0702	Primary voltage		Ufund		V	✓	×
0704	Active power		P		W	✓	×
0706	Reactive power	L3	Q	L3	var	✓	×
0708	Apparent power		S		VA	✓	×
0710	Power distortion factor		dPF		-	✓	×
0712	Active power factor		PF		-	✓	×
0714	tgφ factor		tgφ		-	✓	×
0716	Reserved						
0718	Angle between the voltage and current	L3	φ	L3	rad	✓	×
0720			φ		°	✓	×
0722	Average voltage		Uavg		V	✓	×
0724	Average current		I avg		A	✓	✓
0726	Average primary voltage		Ufavg		V	✓	×
0728	Sum of active power	L123	ΣP	L123	W	✓	×
0730	Sum of reactive power		ΣQ		var	✓	×
0732	Sum of apparent power		ΣS		VA	✓	×

0734	Average value of power distortion factor		dPF		-	✓	✗
0736	Average value of active power factor		PFavg		-	✓	✗
0738	Average value of tgφ factor		tgφavg		-	✓	✗
0740	Phase-to-phase voltage L1-2		Umf L1-2		V	✓	✓
0742	Phase-to-phase voltage L2-3		Umf L2-3		V	✓	✓
0744	Phase-to-phase voltage L3-1		Umf L3-1		V	✓	✓
0746	Average phase-to-phase voltage		Umf avg		V	✓	✓
0748	Average active power	L123	Pavg	L123	W	✓	✗
0750	Average reactive power		Qavg		var	✓	✗
0752	Average apparent power		Savg		VA	✓	✗
0754	Current in neutral wire		IN		A	✓	✗
0756	Recalculated current in neutral wire		INC		A	✓	✗
0758	Average value of angle between voltage and current	L123	φ avg	L123	rad	✓	✗
0760			φ avg		°	✓	✗
0762	Voltage phase-to-phase angle L1-2		∠ U L1-2		°	✓	✓
0764	Voltage phase-to-phase angle L2-3		∠ U L2-3		°	✓	✓
0766	Voltage phase-to-phase angle L3-1		∠ U L3-1		°	✓	✓
0768	Average value of phase-to-phase angle		∠ U avg L123		°	✓	✓
0770	Voltage asymmetry		Vunb		%	✓	✓

4700	Voltage RMS - MAX	Urms	L1	V	✓	✗
4702	Voltage RMS - MIN	Urms		V	✓	✗
4704	Current RMS - MAX	Irms		A	✓	✓
4706	Current RMS - MIN	Irms		A	✓	✓
4708	Primary voltage - MAX	Ufund		V	✓	✗
4710	Primary voltage - MIN	Ufund		V	✓	✗
4712	Active power - MAX	P		W	✓	✗
4714	Active power - MIN	P		W	✓	✗
4716	Reactive power - MAX	Q		var	✓	✗
4718	Reactive power - MIN	Q		var	✓	✗
4720	Apparent power - MAX	S		VA	✓	✗
4322	Apparent power - MIN	S		VA	✓	✗

4724	Voltage RMS - MAX	Urms	V	✓	✗
4726	Voltage RMS - MIN	Urms	V	✓	✗

4728	Current RMS - MAX	Irms	L2	A	✓	✓
4730	Current RMS - MIN	Irms		A	✓	✓
4732	Primary voltage - MAX	Ufund		V	✓	✗
4734	Primary voltage - MIN	Ufund		V	✓	✗
4736	Active power - MAX	P		W	✓	✗
4738	Active power - MIN	P		W	✓	✗
4740	Reactive power - MAX	Q		var	✓	✗
4742	Reactive power - MIN	Q		var	✓	✗
4744	Apparent power - MAX	S		VA	✓	✗
4346	Apparent power - MIN	S		VA	✓	✗

4748	Voltage RMS - MAX	Urms	L3	V	✓	✗
4750	Voltage RMS - MIN	Urms		V	✓	✗
4752	Current RMS - MAX	Irms		A	✓	✓
4754	Current RMS - MIN	Irms		A	✓	✓
4756	Primary voltage - MAX	Ufund		V	✓	✗
4758	Primary voltage - MIN	Ufund		V	✓	✗
4760	Active power - MAX	P		W	✓	✗
4762	Active power - MIN	P		W	✓	✗
4764	Reactive power - MAX	Q		var	✓	✗
4766	Reactive power - MIN	Q		var	✓	✗
4768	Apparent power - MAX	S		VA	✓	✗
4370	Apparent power - MIN	S		VA	✓	✗

### 12.8.9. Parameters averaged in time (Demand)

Register	Parameter	Symbol	Unit	3Ph/ 4W	3Ph/ 3W
0800	Averaged active power (Demand)	P Demand	W	✓	✓
0802	Averaged reactive power (Demand)	Q Demand	var	✓	✓
0804	Averaged apparent power (Demand)	S Demand	VA	✓	✓
0806	Averaged voltage (Demand)	U Demand	V	✓	✓
0808	Averaged current (Demand)	I Demand	A	✓	✓

### 12.8.10. Frequency, temperature/resistance

Register	Parameter	Symbol	Unit	3Ph/ 4W	3Ph/ 3W
0818	Frequency for aggregation of 1 s	f 1s	Hz	✓	✓
0820	Frequency for aggregation of 10 s	f 10s	Hz	✓	✓
0822	Temperature/resistance in first channel	T1	°C / Ω	✓	✓
0824	Temperature/resistance in second channel	T2	°C / Ω	✓	✓
0826	Temperature of analog card	-	°C	✓	✓

### 12.8.11. Flicker

Register	Parameter	Symbol	Unit	3Ph/ 4W	3Ph/ 3W	
0828	1 minute Flicker value	L1	Pst 1min	-	✓	✓
0830		L2		-	✓	✓
0832		L3		-	✓	✓
0834	10 minute Flicker value	L1	Pst 10min	-	✓	✓
0836		L2		-	✓	✓
0838		L3		-	✓	✓
0840	2 hour Flicker value	L1	Plt 2H	-	✓	✓
0842		L2		-	✓	✓
0844		L3		-	✓	✓

### 12.8.12. Statuses of binary inputs

Register	Parameter	Symbol	Unit	3Ph/ 4W	3Ph/ 3W
0852	Binary input no. 1	BI 1	-	✓	✓
0854	Binary input no. 2	BI 2	-	✓	✓
0856	Binary input no. 3	BI 3	-	✓	✓
0858	Binary input no. 4	BI 4	-	✓	✓
0860	Binary input no. 5	BI 5	-	✓	✓
0862	Binary input no. 6	BI 6	-	✓	✓



## 12.8.13. Energy meters

Register	Parameter		Symbol	Unit	3Ph/ 4W	3Ph/ 3W
0900	Active imported energy	L1	EnP+	MWh	✓	✓
0902	Active imported energy		EnP+	kWh	✓	✓
0904	Active imported energy	L2	EnP+	MWh	✓	✓
0906	Active imported energy		EnP+	kWh	✓	✓
0908	Active imported energy	L3	EnP+	MWh	✓	✓
0910	Active imported energy		EnP+	kWh	✓	✓
0912	Sum of active imported energy	L123	$\Sigma$ EnP+	MWh	✓	✓
0914	Sum of active imported energy		$\Sigma$ EnP+	kWh	✓	✓
0916	Active exported energy	L1	EnP-	MWh	✓	✓
0918	Active exported energy		EnP-	kWh	✓	✓
0920	Active exported energy	L2	EnP-	MWh	✓	✓
0922	Active exported energy		EnP-	kWh	✓	✓
0924	Active exported energy	L3	EnP-	MWh	✓	✓
0926	Active exported energy		EnP-	kWh	✓	✓
0928	Sum of active exported energy	L123	$\Sigma$ EnP-	MWh	✓	✓
0930	Sum of active exported energy		$\Sigma$ EnP-	kWh	✓	✓
0932	Reactive imported inductive energy	L1	EnQ+ {	Mvarh	✓	✓
0934	Reactive imported inductive energy		EnQ+ {	kvarh	✓	✓
0936	Reactive imported inductive energy	L2	EnQ+ {	Mvarh	✓	✓
0938	Reactive imported inductive energy		EnQ+ {	kvarh	✓	✓
0940	Reactive imported inductive energy	L3	EnQ+ {	Mvarh	✓	✓
0942	Reactive imported inductive energy		EnQ +{	kvarh	✓	✓
0944	Sum of reactive imported inductive energy	L123	$\Sigma$ EnQ +{	Mvarh	✓	✓
0946	Sum of reactive imported inductive energy		$\Sigma$ EnQ+ {	kvarh	✓	✓
0948	Reactive exported inductive energy	L1	EnQ - {	Mkvarh	✓	✓
0950	Reactive exported inductive energy		EnQ - {	kvarh	✓	✓
0952	Reactive exported inductive energy	L2	EnQ - {	Mvarh	✓	✓
0954	Reactive exported inductive energy		EnQ - {	kvarh	✓	✓
0956	Reactive exported inductive energy	L3	EnQ - {	Mvarh	✓	✓

0958	Reactive exported inductive energy		EnQ - {	kvarh	✓	✓
0960	Sum of reactive exported inductive energy	L123	$\Sigma$ EnQ - {	Mvarh	✓	✓
0962	Sum of reactive exported inductive energy		$\Sigma$ EnQ - {	kvarh	✓	✓
0964	Reactive imported capacity energy	L1	EnQ+ - +	MVAh	✓	✓
0966	Reactive imported capacity energy		EnQ+ - +	kVAh	✓	✓
0968	Reactive imported capacity energy	L2	EnQ+ - +	MVAh	✓	✓
0970	Reactive imported capacity energy		EnQ+ - +	kVAh	✓	✓
0972	Reactive imported capacity energy	L3	EnQ+ - +	MVAh	✓	✓
0974	Reactive imported capacity energy		EnQ+ - +	kVAh	✓	✓
0976	Sum of reactive imported capacity energy	L123	$\Sigma$ EnQ+ - +	MVAh	✓	✓
0978	Sum of reactive imported capacity energy		$\Sigma$ EnQ+ - +	kVAh	✓	✓
0980	Reactive exported capacity energy	L1	EnQ- - +	Mkvarh	✓	✓
0982	Reactive exported capacity energy		EnQ- - +	kvarh	✓	✓
0984	Reactive exported capacity energy	L2	EnQ- - +	Mvarh	✓	✓
0986	Reactive exported capacity energy		EnQ- - +	kvarh	✓	✓
0988	Reactive exported capacity energy	L3	EnQ- - +	Mvarh	✓	✓
0990	Reactive exported capacity energy		EnQ- - +	kvarh	✓	✓
0992	Sum of reactive exported capacity energy	L123	$\Sigma$ EnQ- - +	Mvarh	✓	✓
0994	Sum of reactive exported capacity energy		$\Sigma$ EnQ- - +	kvarh	✓	✓
0996	Apparent energy	L1	EnS	MVAh	✓	✓
0998	Apparent energy		EnS	kVAh	✓	✓
1000	Apparent energy	L2	EnS	MVAh	✓	✓
1002	Apparent energy		EnS	kVAh	✓	✓
1004	Apparent energy	L3	EnS	MVAh	✓	✓
1006	Apparent energy		EnS	kVAh	✓	✓
1008	Sum of apparent energy	L123	$\Sigma$ EnS	MVAh	✓	✓
1010	Sum of apparent energy		$\Sigma$ EnS	kVAh	✓	✓

Recalculation of energy meters available in the registers, for example EnP + L1:

$EnP + L1 = ((\text{Register value } 0900 \times 1000) + \text{register value } 0902) [\text{kWh}]$

other energy values are similarly recalculated.

### 12.8.14. THD, THDS, THDG and PWHD registers

Register	Parameter	Symbol	Unit	3Ph/ 4W	3Ph/ 3W
1050	THD factor of L1 voltage	THD U L1	%	✓	✗
1052	THD factor of L2 voltage	THD U L2	%	✓	✗
1054	THD factor of L3 voltage	THD U L3	%	✓	✗
1056	Average THD value of L123 voltage	THD Uavg L123	%	✓	✗
1058	THD factor of L1 current	THD I L1	%	✓	✓
1060	THD factor of L2 current	THD I L2	%	✓	✓
1062	THD factor of L3 current	THD I L3	%	✓	✓
1064	Average THD value of L123 current	THD Iavg L123	%	✓	✓
1066	THDS factor of L1 voltage	THDS U L1	%	✓	✗
1068	THDS factor of L2 voltage	THDS U L2	%	✓	✗
1070	THDS factor of L3 voltage	THDS U L3	%	✓	✗
1072	Average THDS value of L123 voltage	THDS Uavg L123	%	✓	✗
1074	THDS factor of L1 current	THDS I L1	%	✓	✓
1076	THDS factor of L2 current	THDS I L2	%	✓	✓
1078	THDS factor of L3 current	THDS I L3	%	✓	✓
1080	Average THDS value of L123 current	THDS Iavg L123	%	✓	✓
1082	THDG factor of L1 voltage	THDG U L1	%	✓	✗
1084	THDG factor of L2 voltage	THDG U L2	%	✓	✗
1086	THDG factor of L3 voltage	THDG U L3	%	✓	✗
1088	Average THDG value of L123 voltage	THDG Uavg L123	%	✓	✗
1090	THDG factor of L1 current	THDG I L1	%	✓	✓
1092	THDG factor of L2 current	THDG I L2	%	✓	✓
1094	THDG factor of L3 current	THDG I L3	%	✓	✓
1096	Average THDG value of L123 current	THDG Iavg L123	%	✓	✓
1098	PWHD factor of L1 voltage	PWHD U L1	%	✓	✗
1100	PWHD factor of L2 voltage	PWHD U L2	%	✓	✗
1102	PWHD factor of L3 voltage	PWHD U L3	%	✓	✗
1104	Average PWHD value of L123 voltage	PWHD Uavg L123	%	✓	✗
1106	PWHD factor of L1 current	PWHD I L1	%	✓	✓
1108	PWHD factor of L2 current	PWHD I L2	%	✓	✓
1110	PWHD factor of L3 current	PWHD I L3	%	✓	✓

1112	Average PWHHD value of L123 current	PWHHD Iavg L123	%	✓	✓
------	-------------------------------------	-----------------	---	---	---

### 12.8.15. Harmonics registers

Register	Parameter	Symbol	Unit	3Ph/ 4W	3Ph/ 3W
1150	Harmonic no. 1	Har1	%	✓	✗
1152	Harmonic no. 2	Har2	%	✓	✗
1154	Harmonic no. 3	Har3	%	✓	✗
...	...				
1246	Harmonic no. 49	Har49	%	✓	✗
1248	Harmonic no. 50	Har50	%	✓	✗
1250	Harmonic no. 51	Har51	%	✓	✗
1252	Harmonic no. 1	Hr1	%	✓	✗
1254	Harmonic no. 2	Hr2	%	✓	✗
1256	Harmonic no. 3	Hr3	%	✓	✗
..	...				
1348	Harmonic no. 49	Hr49	%	✓	✗
1350	Harmonic no. 50	Hr50	%	✓	✗
1352	Harmonic no. 51	Hr51	%	✓	✗
1354	Harmonic no. 1	Hr1	%	✓	✗
1356	Harmonic no. 2	Hr2	%	✓	✗
1358	Harmonic no. 3	Hr3	%	✓	✗
..	...				
1450	Harmonic no. 49	Hr49	%	✓	✗
1452	Harmonic no. 50	Hr50	%	✓	✗
1454	Harmonic no. 51	Hr51	%	✓	✗
1456	Harmonic no. 1	Har1	%	✓	✗
1458	Harmonic no. 2	Har2	%	✓	✗
1460	Harmonic no. 3	Har3	%	✓	✗
..	...				
1552	Harmonic no. 49	Har49	%	✓	✗
1554	Harmonic no. 50	Har50	%	✓	✗
1556	Harmonic no. 51	Har51	%	✓	✗
1558	Harmonic no. 1	Har1	%	✓	✗
1560	Harmonic no. 2	Har2	%	✓	✗

1562	Harmonic no. 3		Har3		%	✓	✗
..	...						
1654	Harmonic no. 49		Har49		%	✓	✗
1656	Harmonic no. 50	I L2	Har50	I L2	%	✓	✗
1658	Harmonic no. 51		Har51		%	✓	✗
1660	Harmonic no. 1		Har1		%	✓	✗
1662	Harmonic no. 2	I L3	Har2	I L3	%	✓	✗
1664	Harmonic no. 3		Har3		%	✓	✗
..	...						
1756	Harmonic no. 49		Har49		%	✓	✗
1758	Harmonic no. 50	I L3	Har50	I L3	%	✓	✗
1760	Harmonic no. 51		Har51		%	✓	✗

**12.8.16. Interharmonics registers**

Register	Parameter		Symbol		Unit	3Ph/ 4W	3Ph/ 3W
1762	Interharmonic no. 1	U L1	IHar1	U L1	%	✓	✗
1764	Interharmonic no.2		IHar2		%	✓	✗
1766	Interharmonic no.3		IHar3		%	✓	✗
...	...						
1858	Interharmonic no.49	U L1	IHar49	U L1	%	✓	✗
1860	Interharmonic no.50		IHar50		%	✓	✗
1862	Interharmonic no.51		IHar51		%	✓	✗
1864	Interharmonic no.1	U L2	IHr1	U L2	%	✓	✗
1866	Interharmonic no.2		IHr2		%	✓	✗
1868	Interharmonic no.3		IHr3		%	✓	✗
..	...						
1960	Interharmonic no.49	U L2	IHr49	U L2	%	✓	✗
1962	Interharmonic no.50		IHr50		%	✓	✗
1964	Interharmonic no.51		IHr51		%	✓	✗
1966	Interharmonic no.1	U L3	IHr1	U L3	%	✓	✗
1968	Interharmonic no.2		IHr2		%	✓	✗
1970	Interharmonic no.3		IHr3		%	✓	✗

..	...						
2062	Interharmonic no.49	U L3	I Hr49	U L3	%	✓	✗
2064	Interharmonic no.50		I Hr50		%	✓	✗
2066	Interharmonic no.51		I Hr51		%	✓	✗
2068	Interharmonic no.1	I L1	I Har1	I L1	%	✓	✗
2070	Interharmonic no.2		I Har2		%	✓	✗
2072	Interharmonic no.3		I Har3		%	✓	✗
..	...						
2164	Interharmonic no.49	I L1	I Har49	I L1	%	✓	✗
2166	Interharmonic no.50		I Har50		%	✓	✗
2168	Interharmonic no.51		I Har51		%	✓	✗
2170	Interharmonic no.1	I L2	I Har1	I L2	%	✓	✗
2172	Interharmonic no.2		I Har2		%	✓	✗
2174	Interharmonic no.3		I Har3		%	✓	✗
..	...						
1654	Interharmonic no.49	I L2	I Har49	I L2	%	✓	✗
1656	Interharmonic no.50		I Har50		%	✓	✗
2270	Interharmonic no.51		I Har51		%	✓	✗
2272	Interharmonic no.1	I L3	I Har1	I L3	%	✓	✗
2274	Interharmonic no.2		I Har2		%	✓	✗
2276	Interharmonic no.3		I Har3		%	✓	✗
..	...						
2368	Interharmonic no.49	I L3	I Har49	I L3	%	✓	✗
2370	Interharmonic no.50		I Har50		%	✓	✗
2372	Interharmonic no.51		I Har51		%	✓	✗

### 12.8.17. Voltage half-waves registers

Register	Parameter	50 Hz	60 Hz	Symbol	Unit	3Ph/4W	3Ph/3W
2380	Half-wave value no. 1	✓	✓	Uhalf1	V	✓	✗

2382	Half-wave value no. 2	U L1	✓	✓	Uhalf2	U L1	V	✓	×
2384	Half-wave value no. 3		✓	✓	Uhalf3		V	✓	×
...			...						
2420	Half-wave value no. 21	U L1	×	✓	Uhalf21	U L1	V	✓	×
2422	Half-wave value no. 22		×	✓	Uhalf22		V	✓	×
2424	Half-wave value no. 23		×	✓	Uhalf23		V	✓	×
2426	Half-wave value no. 24		×	✓	Uhalf24		V	✓	×
2428	Half-wave value no. 1	U L2	✓	✓	Uhalf1	U L2	V	✓	×
2430	Half-wave value no. 2		✓	✓	Uhalf2		V	✓	×
2432	Half-wave value no. 3		✓	✓	Uhalf3		V	✓	×
..			...						
2468	Half-wave value no. 21	U L2	×	✓	Uhalf21	U L2	V	✓	×
2470	Half-wave value no. 22		×	✓	Uhalf22		V	✓	×
2472	Half-wave value no. 23		×	✓	Uhalf23		V	✓	×
2474	Half-wave value no. 24		×	✓	Uhalf24		V	✓	×
2476	Half-wave value no. 1	U L3	✓	✓	Uhalf1	U L3	V	✓	×
2478	Half-wave value no. 2		✓	✓	Uhalf2		V	✓	×
2480	Half-wave value no. 3		✓	✓	Uhalf3		V	✓	×
...			...						
2516	Half-wave value no. 21	U L3	×	✓	Uhalf21	U L3	V	✓	×
2518	Half-wave value no. 22		×	✓	Uhalf22		V	✓	×
2520	Half-wave value no. 23		×	✓	Uhalf23		V	✓	×
2522	Half-wave value no. 24		×	✓	Uhalf24		V	✓	×

### 12.8.18. Dips/swells/increases registers

Register	Parametr	50 Hz	60 Hz	Symbol	Unit	3Ph/4W	3Ph/3W	
2579	Event occurrence marker "1" - any event occurred, typing "0" will delete the marker	✓	✓	-	-	✓	×	
Beginning of event								
2580	Event type	Event 1	✓	✓	-	-	✓	×
2581	Event Phase No.		✓	✓	-	-	✓	×

2582	Hour		✓	✓	-	-	✓	×
2583	Minute		✓	✓	-	-	✓	×
2584	Second		✓	✓	-	-	✓	×
2585	Milisecond		✓	✓	-	-	✓	×
2586	Year		✓	✓	-	-	✓	×
2587	Month		✓	✓	-	-	✓	×
2588	Day		✓	✓	-	-	✓	×
2589	Event type	Event 2	✓	✓	-	-	✓	×
2590	Event Phase No.		✓	✓	-	-	✓	×
2591	Hour		✓	✓	-	-	✓	×
2592	Minute		✓	✓	-	-	✓	×
2593	Second		✓	✓	-	-	✓	×
2594	Milisecond		✓	✓	-	-	✓	×
2595	Year		✓	✓	-	-	✓	×
2596	Month		✓	✓	-	-	✓	×
2597	Day		✓	✓	-	-	✓	×
2598	Event type	Event 3	✓	✓	-	-	✓	×
2599	Event Phase No.		✓	✓	-	-	✓	×
2600	Hour		✓	✓	-	-	✓	×
2601	Minute		✓	✓	-	-	✓	×
2602	Second		✓	✓	-	-	✓	×
2603	Milisecond		✓	✓	-	-	✓	×
2604	Year		✓	✓	-	-	✓	×
2605	Month		✓	✓	-	-	✓	×
2606	Day		✓	✓	-	-	✓	×
2607	Event type	Event 4	✓	✓	-	-	✓	×
2608	Event Phase No.		✓	✓	-	-	✓	×
2609	Hour		✓	✓	-	-	✓	×
2610	Minute		✓	✓	-	-	✓	×
2611	Second		✓	✓	-	-	✓	×
2612	Milisecond		✓	✓	-	-	✓	×
2613	Year		✓	✓	-	-	✓	×
2614	Month		✓	✓	-	-	✓	×



2615	Day	Event 5	✓	✓	-	-	✓	×
2616	Event type		✓	✓	-	-	✓	×
2617	Event Phase No.		✓	✓	-	-	✓	×
2618	Hour		✓	✓	-	-	✓	×
2619	Minute		✓	✓	-	-	✓	×
2620	Second		✓	✓	-	-	✓	×
2621	Milisecond		✓	✓	-	-	✓	×
2622	Year		✓	✓	-	-	✓	×
2623	Month		✓	✓	-	-	✓	×
2624	Day	Event 6	✓	✓	-	-	✓	×
2625	Event type		✓	✓	-	-	✓	×
2626	Event Phase No.		✓	✓	-	-	✓	×
2627	Hour		✓	✓	-	-	✓	×
2628	Minute		✓	✓	-	-	✓	×
2629	Second		✓	✓	-	-	✓	×
2630	Milisecond		✓	✓	-	-	✓	×
2631	Year		✓	✓	-	-	✓	×
2632	Month		✓	✓	-	-	✓	×
2633	Day	Event 7	✓	✓	-	-	✓	×
2634	Event type		✓	✓	-	-	✓	×
2635	Event Phase No.		✓	✓	-	-	✓	×
2636	Hour		✓	✓	-	-	✓	×
2637	Minute		✓	✓	-	-	✓	×
2638	Second		✓	✓	-	-	✓	×
2639	Milisecond		✓	✓	-	-	✓	×
2640	Year		✓	✓	-	-	✓	×
2641	Month		✓	✓	-	-	✓	×
2642	Day	Event 8	✓	✓	-	-	✓	×
2643	Event type		✓	✓	-	-	✓	×
2644	Event Phase No.		✓	✓	-	-	✓	×
2645	Hour		✓	✓	-	-	✓	×
2646	Minute		✓	✓	-	-	✓	×
2647	Second	✓	✓	-	-	✓	×	

2648	Milisecond		✓	✓	-	-	✓	×
2659	Year		✓	✓	-	-	✓	×
2660	Month		✓	✓	-	-	✓	×
2661	Day		✓	✓	-	-	✓	×
2662	Event type	Event 9	✓	✓	-	-	✓	×
2663	Event Phase No.		✓	✓	-	-	✓	×
2664	Hour		✓	✓	-	-	✓	×
2665	Minute		✓	✓	-	-	✓	×
2666	Second		✓	✓	-	-	✓	×
2667	Milisecond		✓	✓	-	-	✓	×
2668	Year		✓	✓	-	-	✓	×
2669	Month		✓	✓	-	-	✓	×
2670	Day		✓	✓	-	-	✓	×
2671	Event type	Event 10	✓	✓	-	-	✓	×
2672	Event Phase No.		✓	✓	-	-	✓	×
2673	Hour		✓	✓	-	-	✓	×
2674	Minute		✓	✓	-	-	✓	×
2675	Second		✓	✓	-	-	✓	×
2676	Milisecond		✓	✓	-	-	✓	×
2677	Year		✓	✓	-	-	✓	×
2678	Month		✓	✓	-	-	✓	×
2679	Day		✓	✓	-	-	✓	×
End of event								
2680	Event type	Event 1	✓	✓	-	-	✓	×
2681	Event Phase No.		✓	✓	-	-	✓	×
2682	L1 integer value		✓	✓	-	-	✓	×
2683	L1 fractional value		✓	✓	-	-	✓	×
2684	L2 integer value		✓	✓	-	-	✓	×
2685	L2 fractional value		✓	✓	-	-	✓	×
2686	L3 integer value		✓	✓	-	-	✓	×
2687	L3 fractional value		✓	✓	-	-	✓	×
2688	Duration (hours)		✓	✓	-	-	✓	×
2689	Duration (minutes)		✓	✓	-	-	✓	×

2690	Duration (seconds)		✓	✓	-	-	✓	×
2691	Duration (milliseconds)		✓	✓	-	-	✓	×
2692	Event type	Event 2	✓	✓	-	-	✓	×
2693	Event Phase No.		✓	✓	-	-	✓	×
2694	L1 total value		✓	✓	-	-	✓	×
2695	L1 fractional value		✓	✓	-	-	✓	×
2696	L2 total value		✓	✓	-	-	✓	×
2697	L2 fractional value		✓	✓	-	-	✓	×
2698	L3 total value		✓	✓	-	-	✓	×
2699	L3 fractional value		✓	✓	-	-	✓	×
2700	Duration (hours)		✓	✓	-	-	✓	×
2701	Duration (minutes)		✓	✓	-	-	✓	×
2702	Duration (seconds)		✓	✓	-	-	✓	×
2703	Duration (miliseconds)		✓	✓	-	-	✓	×
2704	Event type		Event 3	✓	✓	-	-	✓
2705	Event Phase No.	✓		✓	-	-	✓	×
2706	L1 total value	✓		✓	-	-	✓	×
2707	L1 fractional value	✓		✓	-	-	✓	×
2708	L2 total value	✓		✓	-	-	✓	×
2709	L2 fractional value	✓		✓	-	-	✓	×
2710	L3 total value	✓		✓	-	-	✓	×
2711	L3 fractional value	✓		✓	-	-	✓	×
2712	Duration (hours)	✓		✓	-	-	✓	×
2713	Duration (minutes)	✓		✓	-	-	✓	×
2714	Duration (seconds)	✓		✓	-	-	✓	×
2715	Duration (miliseconds)	✓	✓	-	-	✓	×	
2716	Event type	Event 4	✓	✓	-	-	✓	×
2717	Event Phase No.		✓	✓	-	-	✓	×
2718	L1 total value		✓	✓	-	-	✓	×
2719	L1 fractional value		✓	✓	-	-	✓	×
2720	L2 total value		✓	✓	-	-	✓	×
2721	L2 fractional value		✓	✓	-	-	✓	×
2722	L3 total value		✓	✓	-	-	✓	×

2723	L3 fractional value		✓	✓	-	-	✓	×
2724	Duration (hours)		✓	✓	-	-	✓	×
2725	Duration (minutes)		✓	✓	-	-	✓	×
2726	Duration (seconds)		✓	✓	-	-	✓	×
2727	Duration (milliseconds)		✓	✓	-	-	✓	×
2728	Event type	Event 5	✓	✓	-	-	✓	×
2729	Event Phase No.		✓	✓	-	-	✓	×
2730	L1 total value		✓	✓	-	-	✓	×
2731	L1 fractional value		✓	✓	-	-	✓	×
2732	L2 total value		✓	✓	-	-	✓	×
2733	L2 fractional value		✓	✓	-	-	✓	×
2734	L3 total value		✓	✓	-	-	✓	×
2735	L3 fractional value		✓	✓	-	-	✓	×
2736	Duration (hours)		✓	✓	-	-	✓	×
2737	Duration (minutes)		✓	✓	-	-	✓	×
2738	Duration (seconds)		✓	✓	-	-	✓	×
2739	Duration (milliseconds)		✓	✓	-	-	✓	×
2740	Event type	Event 6	✓	✓	-	-	✓	×
2741	Event Phase No.		✓	✓	-	-	✓	×
2742	L1 total value		✓	✓	-	-	✓	×
2743	L1 fractional value		✓	✓	-	-	✓	×
2744	L2 total value		✓	✓	-	-	✓	×
2745	L2 fractional value		✓	✓	-	-	✓	×
2746	L3 total value		✓	✓	-	-	✓	×
2747	L3 fractional value		✓	✓	-	-	✓	×
2748	Duration (hours)		✓	✓	-	-	✓	×
2749	Duration (minutes)		✓	✓	-	-	✓	×
2750	Duration (seconds)		✓	✓	-	-	✓	×
2751	Duration (milliseconds)		✓	✓	-	-	✓	×
2752	Event type	Event 7	✓	✓	-	-	✓	×
2753	Event Phase No.		✓	✓	-	-	✓	×
2754	L1 total value		✓	✓	-	-	✓	×
2755	L1 fractional value		✓	✓	-	-	✓	×

2756	L2 total value		✓	✓	-	-	✓	×
2757	L2 fractional value		✓	✓	-	-	✓	×
2758	L3 total value		✓	✓	-	-	✓	×
2759	L3 fractional value		✓	✓	-	-	✓	×
2760	Duration (hours)		✓	✓	-	-	✓	×
2761	Duration (minutes)		✓	✓	-	-	✓	×
2762	Duration (seconds)		✓	✓	-	-	✓	×
2763	Duration (milliseconds)		✓	✓	-	-	✓	×
2764	Event type	Event 8	✓	✓	-	-	✓	×
2765	Event Phase No.		✓	✓	-	-	✓	×
2766	L1 total value		✓	✓	-	-	✓	×
2767	L1 fractional value		✓	✓	-	-	✓	×
2768	L2 total value		✓	✓	-	-	✓	×
2769	L2 fractional value		✓	✓	-	-	✓	×
2770	L3 total value		✓	✓	-	-	✓	×
2771	L3 fractional value		✓	✓	-	-	✓	×
2772	Duration (hours)		✓	✓	-	-	✓	×
2773	Duration (minutes)		✓	✓	-	-	✓	×
2774	Duration (seconds)		✓	✓	-	-	✓	×
2775	Duration (milliseconds)		✓	✓	-	-	✓	×
2776	Event type	Event 9	✓	✓	-	-	✓	×
2777	Event Phase No.		✓	✓	-	-	✓	×
2778	L1 total value		✓	✓	-	-	✓	×
2779	L1 fractional value		✓	✓	-	-	✓	×
2780	L2 total value		✓	✓	-	-	✓	×
2781	L2 fractional value		✓	✓	-	-	✓	×
2782	L3 total value		✓	✓	-	-	✓	×
2783	L3 fractional value		✓	✓	-	-	✓	×
2784	Duration (hours)		✓	✓	-	-	✓	×
2785	Duration (minutes)		✓	✓	-	-	✓	×
2786	Duration (seconds)		✓	✓	-	-	✓	×
2787	Duration (milliseconds)		✓	✓	-	-	✓	×
2788	Event type	Event 10	✓	✓	-	-	✓	×

2789	Event Phase No.	✓	✓	-	-	✓	×
2790	L1 total value	✓	✓	-	-	✓	×
2791	L1 fractional value	✓	✓	-	-	✓	×
2792	L2 total value	✓	✓	-	-	✓	×
2793	L2 fractional value	✓	✓	-	-	✓	×
2794	L3 total value	✓	✓	-	-	✓	×
2795	L3 fractional value	✓	✓	-	-	✓	×
2796	Duration (hours)	✓	✓	-	-	✓	×
2797	Duration (minutes)	✓	✓	-	-	✓	×
2798	Duration (seconds)	✓	✓	-	-	✓	×
2799	Duration (milliseconds)	✓	✓	-	-	✓	×

### 12.8.19. Pulse and energy counters from the external card

Register	Parametr	50 Hz	60 Hz	Symbol	Unit	3Ph/ 4W	3Ph/ 3W
2800	Output 1 pulse counter	✓	✓	-	imp	✓	✓
2802	Output 2 pulse counter	✓	✓	-	imp	✓	✓
2804	Output 3 pulse counter	✓	✓	-	imp	✓	✓
2806	Output 4 pulse counter	✓	✓	-	imp	✓	✓
2808	Output 5 pulse counter	✓	✓	-	imp	✓	✓
2810	Output 6 pulse counter	✓	✓	-	imp	✓	✓
2812	Output 1 energy counter	✓	✓	-	kWh	✓	✓
2814	Output 2 energy counter	✓	✓	-	kWh	✓	✓
2816	Output 3 energy counter	✓	✓	-	kWh	✓	✓
2818	Output 4 energy counter	✓	✓	-	kWh	✓	✓
2820	Output 5 energy counter	✓	✓	-	kWh	✓	✓
2822	Output 6 energy counter	✓	✓	-	kWh	✓	✓

## 12.8.20. Tariffs

Register	Parameter	Symbol		Unit	3Ph/ 4W	3Ph / 3W
Tariff 1						
2850	Active imported energy	L1	EnP+	MWh	✓	✓
2852	Active imported energy	L1	EnP+	kWh	✓	✓
2854	Active imported energy	L2	EnP+	MWh	✓	✓
2856	Active imported energy	L2	EnP+	kWh	✓	✓
2858	Active imported energy	L3	EnP+	MWh	✓	✓
2860	Active imported energy	L3	EnP+	kWh	✓	✓
2862	Sum of active imported energy	L123	$\Sigma$ EnP+	MWh	✓	✓
2864	Sum of active imported energy	L123	$\Sigma$ EnP+	kWh	✓	✓
2866	Active exported energy	L1	EnP-	MWh	✓	✓
2868	Active exported energy	L1	EnP-	kWh	✓	✓
2870	Active exported energy	L2	EnP-	MWh	✓	✓
2872	Active exported energy	L2	EnP-	kWh	✓	✓
2874	Active exported energy	L3	EnP-	MWh	✓	✓
2876	Active exported energy	L3	EnP-	kWh	✓	✓
2878	Sum of active exported energy	L123	$\Sigma$ EnP-	MWh	✓	✓
2880	Sum of active exported energy	L123	$\Sigma$ EnP-	kWh	✓	✓
2882	Reactive imported inductive energy	L1	EnQ+ $\xi$	Mvarh	✓	✓
2884	Reactive imported inductive energy	L1	EnQ+ $\xi$	kvarh	✓	✓
2886	Reactive imported inductive energy	L2	EnQ+ $\xi$	Mvarh	✓	✓
2888	Reactive imported inductive energy	L2	EnQ+ $\xi$	kvarh	✓	✓
2890	Reactive imported inductive energy	L3	EnQ+ $\xi$	Mvarh	✓	✓
2892	Reactive imported inductive energy	L3	EnQ+ $\xi$	kvarh	✓	✓
2894	Sum of reactive imported inductive energy	L123	$\Sigma$ EnQ+ $\xi$	Mvarh	✓	✓
2896	Sum of reactive imported inductive energy	L123	$\Sigma$ EnQ+ $\xi$	kvarh	✓	✓
2898	Reactive exported capacitive energy	L1	EnQ- $\xi$	Mvarh	✓	✓
2900	Reactive exported capacitive energy	L1	EnQ- $\xi$	kvarh	✓	✓
2902	Reactive exported capacitive energy	L2	EnQ- $\xi$	Mvarh	✓	✓

2904	Reactive exported capacitive energy	L2	EnQ- $\xi$	kvarh	✓	✓
2906	Reactive exported capacitive energy	L3	EnQ- $\xi$	Mvarh	✓	✓
2908	Reactive exported capacitive energy	L3	EnQ- $\xi$	kvarh	✓	✓
2910	Sum of reactive exported capacitive energy	L123	$\Sigma$ EnQ- $\xi$	Mvarh	✓	✓
2912	Sum of reactive exported capacitive energy	L123	$\Sigma$ EnQ- $\xi$	kvarh	✓	✓
2914	Reactive imported inductive energy	L1	EnQ+ $\neg$ $\neg$	Mvarh	✓	✓
2916	Reactive imported inductive energy	L1	EnQ+ $\neg$ $\neg$	kvarh	✓	✓
2918	Reactive imported inductive energy	L2	EnQ+ $\neg$ $\neg$	Mvarh	✓	✓
2920	Reactive imported inductive energy	L2	EnQ+ $\neg$ $\neg$	kvarh	✓	✓
2922	Reactive imported inductive energy	L3	EnQ+ $\neg$ $\neg$	Mvarh	✓	✓
2924	Reactive imported inductive energy	L3	EnQ+ $\neg$ $\neg$	kvarh	✓	✓
2926	Sum of reactive imported inductive energy	L123	$\Sigma$ EnQ+ $\neg$ $\neg$	Mvarh	✓	✓
2928	Sum of reactive imported inductive energy	L123	$\Sigma$ EnQ+ $\neg$ $\neg$	kvarh	✓	✓
2930	Reactive exported capacitive energy	L1	EnQ- $\neg$ $\neg$	Mvarh	✓	✓
2932	Reactive exported capacitive energy	L1	EnQ- $\neg$ $\neg$	kvarh	✓	✓
2934	Reactive exported capacitive energy	L2	EnQ- $\neg$ $\neg$	Mvarh	✓	✓
2936	Reactive exported capacitive energy	L2	EnQ- $\neg$ $\neg$	kvarh	✓	✓
2938	Reactive exported capacitive energy	L3	EnQ- $\neg$ $\neg$	Mvarh	✓	✓
2940	Reactive exported capacitive energy	L3	EnQ- $\neg$ $\neg$	kvarh	✓	✓
2942	Sum of reactive exported capacitive energy	L123	$\Sigma$ EnQ- $\neg$ $\neg$	Mvarh	✓	✓
2944	Sum of reactive exported capacitive energy	L123	$\Sigma$ EnQ- $\neg$ $\neg$	kvarh	✓	✓
2946	Apparent energy	L1	EnS	MVAh	✓	✓
2948	Apparent energy	L1	EnS	kVAh	✓	✓
2950	Apparent energy	L2	EnS	MVAh	✓	✓
2952	Apparent energy	L2	EnS	kVAh	✓	✓
2954	Apparent energy	L3	EnS	MVAh	✓	✓
2956	Apparent energy	L3	EnS	kVAh	✓	✓
2958	Sum of apparent energy	L123	$\Sigma$ EnS	MVAh	✓	✓
2960	Sum of apparent energy	L123	$\Sigma$ EnS	kVAh	✓	✓
Tariff 2						
2962	Active imported energy	L1	EnP+	MWh	✓	✓



2966	Active imported energy	L1	EnP+	kWh	✓	✓
2966	Active imported energy	L2	EnP+	MWh	✓	✓
2968	Active imported energy	L2	EnP+	kWh	✓	✓
2970	Active imported energy	L3	EnP+	MWh	✓	✓
2972	Active imported energy	L3	EnP+	kWh	✓	✓
2974	Sum of active imported energy	L123	$\Sigma$ EnP+	MWh	✓	✓
2976	Sum of active imported energy	L123	$\Sigma$ EnP+	kWh	✓	✓
2978	Active exported energy	L1	EnP-	MWh	✓	✓
2980	Active exported energy	L1	EnP-	kWh	✓	✓
2982	Active exported energy	L2	EnP-	MWh	✓	✓
2984	Active exported energy	L2	EnP-	kWh	✓	✓
2986	Active exported energy	L3	EnP-	MWh	✓	✓
2988	Active exported energy	L3	EnP-	kWh	✓	✓
2990	Sum of active exported energy	L123	$\Sigma$ EnP-	MWh	✓	✓
2992	Sum of active exported energy	L123	$\Sigma$ EnP-	kWh	✓	✓
2994	Reactive imported inductive energy	L1	EnQ+ $\xi$	Mvarh	✓	✓
2996	Reactive imported inductive energy	L1	EnQ+ $\xi$	kvarh	✓	✓
2998	Reactive imported inductive energy	L2	EnQ+ $\xi$	Mvarh	✓	✓
3000	Reactive imported inductive energy	L2	EnQ+ $\xi$	kvarh	✓	✓
3002	Reactive imported inductive energy	L3	EnQ+ $\xi$	Mvarh	✓	✓
3004	Reactive imported inductive energy	L3	EnQ+ $\xi$	kvarh	✓	✓
3006	Sum of reactive imported inductive energy	L123	$\Sigma$ EnQ+ $\xi$	Mvarh	✓	✓
3008	Sum of reactive imported inductive energy	L123	$\Sigma$ EnQ+ $\xi$	kvarh	✓	✓
3010	Reactive exported capacitive energy	L1	EnQ- $\xi$	Mvarh	✓	✓
3012	Reactive exported capacitive energy	L1	EnQ- $\xi$	kvarh	✓	✓
3014	Reactive exported capacitive energy	L2	EnQ- $\xi$	Mvarh	✓	✓
3016	Reactive exported capacitive energy	L2	EnQ- $\xi$	kvarh	✓	✓
3018	Reactive exported capacitive energy	L3	EnQ- $\xi$	Mvarh	✓	✓
3020	Reactive exported capacitive energy	L3	EnQ- $\xi$	kvarh	✓	✓
3022	Sum of reactive exported capacitive energy	L123	$\Sigma$ EnQ- $\xi$	Mvarh	✓	✓
3024	Sum of reactive exported capacitive energy	L123	$\Sigma$ EnQ- $\xi$	kvarh	✓	✓

3026	Reactive imported inductive energy	L1	EnQ+ -+-	Mvarh	✓	✓
3028	Reactive imported inductive energy	L1	EnQ+ -+-	kvarh	✓	✓
3030	Reactive imported inductive energy	L2	EnQ+ -+-	Mvarh	✓	✓
3032	Reactive imported inductive energy	L2	EnQ+ -+-	kvarh	✓	✓
3034	Reactive imported inductive energy	L3	EnQ+ -+-	Mvarh	✓	✓
3036	Reactive imported inductive energy	L3	EnQ+ -+-	kvarh	✓	✓
3038	Sum of reactive imported inductive energy	L123	$\Sigma$ EnQ+ -+-	Mvarh	✓	✓
3040	Sum of reactive imported inductive energy	L123	$\Sigma$ EnQ+ -+-	kvarh	✓	✓
3042	Reactive exported capacitive energy	L1	EnQ- -+-	Mvarh	✓	✓
3044	Reactive exported capacitive energy	L1	EnQ- -+-	kvarh	✓	✓
3046	Reactive exported capacitive energy	L2	EnQ- -+-	Mvarh	✓	✓
3048	Reactive exported capacitive energy	L2	EnQ- -+-	kvarh	✓	✓
3050	Reactive exported capacitive energy	L3	EnQ- -+-	Mvarh	✓	✓
3052	Reactive exported capacitive energy	L3	EnQ- -+-	kvarh	✓	✓
3054	Sum of reactive exported capacitive energy	L123	$\Sigma$ EnQ- -+-	Mvarh	✓	✓
3056	Sum of reactive exported capacitive energy	L123	$\Sigma$ EnQ- -+-	kvarh	✓	✓
3058	Apparent energy	L1	EnS	MVAh	✓	✓
3060	Apparent energy	L1	EnS	kVAh	✓	✓
3062	Apparent energy	L2	EnS	MVAh	✓	✓
3064	Apparent energy	L2	EnS	kVAh	✓	✓
3066	Apparent energy	L3	EnS	MVAh	✓	✓
3068	Apparent energy	L3	EnS	kVAh	✓	✓
3070	Sum of apparent energy	L123	$\Sigma$ EnS	MVAh	✓	✓
3072	Sum of apparent energy	L123	$\Sigma$ EnS	kVAh	✓	✓
<b>Tariff 3</b>						
3074	Active imported energy	L1	EnP+	MWh	✓	✓
3076	Active imported energy	L1	EnP+	kWh	✓	✓
3078	Active imported energy	L2	EnP+	MWh	✓	✓
3080	Active imported energy	L2	EnP+	kWh	✓	✓
3082	Active imported energy	L3	EnP+	MWh	✓	✓
3084	Active imported energy	L3	EnP+	kWh	✓	✓

3086	Sum of active imported energy	L123	$\Sigma EnP+$	MWh	✓	✓
3088	Sum of active imported energy	L123	$\Sigma EnP+$	kWh	✓	✓
3090	Active exported energy	L1	EnP-	MWh	✓	✓
3092	Active exported energy	L1	EnP-	kWh	✓	✓
3094	Active exported energy	L2	EnP-	MWh	✓	✓
3096	Active exported energy	L2	EnP-	kWh	✓	✓
3098	Active exported energy	L3	EnP-	MWh	✓	✓
3100	Active exported energy	L3	EnP-	kWh	✓	✓
3102	Sum of active exported energy	L123	$\Sigma EnP-$	MWh	✓	✓
3104	Sum of active exported energy	L123	$\Sigma EnP-$	kWh	✓	✓
3106	Reactive imported inductive energy	L1	EnQ+ $\xi$	Mvarh	✓	✓
3108	Reactive imported inductive energy	L1	EnQ+ $\xi$	kvarh	✓	✓
3110	Reactive imported inductive energy	L2	EnQ+ $\xi$	Mvarh	✓	✓
3112	Reactive imported inductive energy	L2	EnQ+ $\xi$	kvarh	✓	✓
3114	Reactive imported inductive energy	L3	EnQ+ $\xi$	Mvarh	✓	✓
3116	Reactive imported inductive energy	L3	EnQ+ $\xi$	kvarh	✓	✓
3118	Sum of reactive imported inductive energy	L123	$\Sigma EnQ+ \xi$	Mvarh	✓	✓
3120	Sum of reactive imported inductive energy	L123	$\Sigma EnQ+ \xi$	kvarh	✓	✓
3122	Reactive exported capacitive energy	L1	EnQ- $\xi$	Mvarh	✓	✓
3124	Reactive exported capacitive energy	L1	EnQ- $\xi$	kvarh	✓	✓
3126	Reactive exported capacitive energy	L2	EnQ- $\xi$	Mvarh	✓	✓
3128	Reactive exported capacitive energy	L2	EnQ- $\xi$	kvarh	✓	✓
3130	Reactive exported capacitive energy	L3	EnQ- $\xi$	Mvarh	✓	✓
3132	Reactive exported capacitive energy	L3	EnQ- $\xi$	kvarh	✓	✓
3134	Sum of reactive exported capacitive energy	L123	$\Sigma EnQ- \xi$	Mvarh	✓	✓
3136	Sum of reactive exported capacitive energy	L123	$\Sigma EnQ- \xi$	kvarh	✓	✓
3138	Reactive imported inductive energy	L1	EnQ+ $\text{- +}$	Mvarh	✓	✓
3140	Reactive imported inductive energy	L1	EnQ+ $\text{- +}$	kvarh	✓	✓
3142	Reactive imported inductive energy	L2	EnQ+ $\text{- +}$	Mvarh	✓	✓
3144	Reactive imported inductive energy	L2	EnQ+ $\text{- +}$	kvarh	✓	✓
3146	Reactive imported inductive energy	L3	EnQ+ $\text{- +}$	Mvarh	✓	✓

3148	Reactive imported inductive energy	L3	EnQ+ -I-	kvarh	✓	✓
3150	Sum of reactive imported inductive energy	L123	$\Sigma$ EnQ+ -I-	Mvarh	✓	✓
3152	Sum of reactive imported inductive energy	L123	$\Sigma$ EnQ+ -I-	kvarh	✓	✓
3154	Reactive exported capacitive energy	L1	EnQ- -I-	Mvarh	✓	✓
3156	Reactive exported capacitive energy	L1	EnQ- -I-	kvarh	✓	✓
3158	Reactive exported capacitive energy	L2	EnQ- -I-	Mvarh	✓	✓
3160	Reactive exported capacitive energy	L2	EnQ- -I-	kvarh	✓	✓
3162	Reactive exported capacitive energy	L3	EnQ- -I-	Mvarh	✓	✓
3164	Reactive exported capacitive energy	L3	EnQ- -I-	kvarh	✓	✓
3166	Sum of reactive exported capacitive energy	L123	$\Sigma$ EnQ- -I-	Mvarh	✓	✓
3168	Sum of reactive exported capacitive energy	L123	$\Sigma$ EnQ- -I-	kvarh	✓	✓
3170	Apparent energy	L1	EnS	MVAh	✓	✓
3172	Apparent energy	L1	EnS	kVAh	✓	✓
3174	Apparent energy	L2	EnS	MVAh	✓	✓
3176	Apparent energy	L2	EnS	kVAh	✓	✓
3178	Apparent energy	L3	EnS	MVAh	✓	✓
3180	Apparent energy	L3	EnS	kVAh	✓	✓
3182	Sum of apparent energy	L123	$\Sigma$ EnS	MVAh	✓	✓
3184	Sum of apparent energy	L123	$\Sigma$ EnS	kVAh	✓	✓
Tariff 4						
3186	Active imported energy	L1	EnP+	MWh	✓	✓
3188	Active imported energy	L1	EnP+	kWh	✓	✓
3190	Active imported energy	L2	EnP+	MWh	✓	✓
3192	Active imported energy	L2	EnP+	kWh	✓	✓
3194	Active imported energy	L3	EnP+	MWh	✓	✓
3196	Active imported energy	L3	EnP+	kWh	✓	✓
3198	Sum of active imported energy	L123	$\Sigma$ EnP+	MWh	✓	✓
3200	Sum of active imported energy	L123	$\Sigma$ EnP+	kWh	✓	✓
3202	Active exported energy	L1	EnP-	MWh	✓	✓
3204	Active exported energy	L1	EnP-	kWh	✓	✓
3206	Active exported energy	L2	EnP-	MWh	✓	✓

3208	Active exported energy	L2	EnP-	kWh	✓	✓
3210	Active exported energy	L3	EnP-	MWh	✓	✓
3212	Active exported energy	L3	EnP-	kWh	✓	✓
3214	Sum of active exported energy	L123	$\Sigma$ EnP-	MWh	✓	✓
3216	Sum of active exported energy	L123	$\Sigma$ EnP-	kWh	✓	✓
3218	Reactive imported inductive energy	L1	EnQ+ $\xi$	Mvarh	✓	✓
3220	Reactive imported inductive energy	L1	EnQ+ $\xi$	kvarh	✓	✓
3222	Reactive imported inductive energy	L2	EnQ+ $\xi$	Mvarh	✓	✓
3224	Reactive imported inductive energy	L2	EnQ+ $\xi$	kvarh	✓	✓
3226	Reactive imported inductive energy	L3	EnQ+ $\xi$	Mvarh	✓	✓
3228	Reactive imported inductive energy	L3	EnQ+ $\xi$	kvarh	✓	✓
3230	Sum of reactive imported inductive energy	L123	$\Sigma$ EnQ+ $\xi$	Mvarh	✓	✓
3232	Sum of reactive imported inductive energy	L123	$\Sigma$ EnQ+ $\xi$	kvarh	✓	✓
3234	Reactive exported capacitive energy	L1	EnQ- $\xi$	Mvarh	✓	✓
3236	Reactive exported capacitive energy	L1	EnQ- $\xi$	kvarh	✓	✓
3238	Reactive exported capacitive energy	L2	EnQ- $\xi$	Mvarh	✓	✓
3240	Reactive exported capacitive energy	L2	EnQ- $\xi$	kvarh	✓	✓
3242	Reactive exported capacitive energy	L3	EnQ- $\xi$	Mvarh	✓	✓
3244	Reactive exported capacitive energy	L3	EnQ- $\xi$	kvarh	✓	✓
3246	Sum of reactive exported capacitive energy	L123	$\Sigma$ EnQ- $\xi$	Mvarh	✓	✓
3248	Sum of reactive exported capacitive energy	L123	$\Sigma$ EnQ- $\xi$	kvarh	✓	✓
3250	Reactive imported inductive energy	L1	EnQ+ $\text{-}+\text{-}$	Mvarh	✓	✓
3252	Reactive imported inductive energy	L1	EnQ+ $\text{-}+\text{-}$	kvarh	✓	✓
3254	Reactive imported inductive energy	L2	EnQ+ $\text{-}+\text{-}$	Mvarh	✓	✓
3256	Reactive imported inductive energy	L2	EnQ+ $\text{-}+\text{-}$	kvarh	✓	✓
3258	Reactive imported inductive energy	L3	EnQ+ $\text{-}+\text{-}$	Mvarh	✓	✓
3260	Reactive imported inductive energy	L3	EnQ+ $\text{-}+\text{-}$	kvarh	✓	✓
3262	Sum of reactive imported inductive energy	L123	$\Sigma$ EnQ+ $\text{-}+\text{-}$	Mvarh	✓	✓
3264	Suma energii biernej indukcyjnej pobierana	L123	$\Sigma$ EnQ+ $\text{-}+\text{-}$	kvarh	✓	✓
3266	Reactive exported capacitive energy	L1	EnQ- $\text{-}+\text{-}$	Mvarh	✓	✓
3268	Reactive exported capacitive energy	L1	EnQ- $\text{-}+\text{-}$	kvarh	✓	✓

3270	Reactive exported capacitive energy	L2	EnQ- -+†	Mvarh	✓	✓
3272	Reactive exported capacitive energy	L2	EnQ- -+†	kvarh	✓	✓
3274	Reactive exported capacitive energy	L3	EnQ- -+†	Mvarh	✓	✓
3276	Reactive exported capacitive energy	L3	EnQ- -+†	kvarh	✓	✓
3278	Sum of reactive exported capacitive energy	L123	ΣEnQ- -+†	Mvarh	✓	✓
3280	Sum of reactive exported capacitive energy	L123	ΣEnQ- -+†	kvarh	✓	✓
3282	Apparent energy	L1	EnS	MVAh	✓	✓
3284	Apparent energy	L1	EnS	kVAh	✓	✓
3286	Apparent energy	L2	EnS	MVAh	✓	✓
3288	Apparent energy	L2	EnS	kVAh	✓	✓
3290	Apparent energy	L3	EnS	MVAh	✓	✓
3292	Apparent energy	L3	EnS	kVAh	✓	✓
3294	Sum of apparent energy	L123	ΣEnS	MVAh	✓	✓
3296	Sum of apparent energy	L123	ΣEnS	kVAh	✓	✓

Recalculation of energy meters available in the registers, for example EnP + L1:  
 $EnP + L1 = ((Register\ value\ 2850 \times 1000) + register\ value\ 2852)$  [kWh]  
 other energy values are similarly recalculated.

### 13. Ordering codes

Code	Description
<b>ND45 1010M000*</b>	Power Network Analyzer/ Recorder ND45 Input current 1A/5A, X/1A, X/5A, Input voltage 3x57.7/100V, Measuring class S, Ethernet, RS485, USB interfaces, memory up to 32GB, supply 85-253V a.c. or 90-300V d.c., documentation and descriptions in Polish and English version, test certificate
<b>ND45 1011M000*</b>	Power Network Analyzer/ Recorder ND45 Input current 1A/5A, X/1A, X/5A, Input voltage 3x57.7/100V, Measuring class A/S, Ethernet, RS485, USB interfaces, memory up to 32GB, supply 85-253V a.c. or 90-300V d.c., documentation and descriptions in Polish and English version, test certificate
<b>ND45 2010M000*</b>	Power Network Analyzer/ Recorder ND45 Input current 1A/5A, X/1A, X/5A, Input voltage 3x230/400V, Measuring class S, Ethernet, RS485, USB interfaces, memory up to 32GB, supply 85-253V a.c. or 90-300V d.c., documentation and descriptions in Polish and English version, test certificate
<b>ND45 2011M000*</b>	Power Network Analyzer/ Recorder ND45 Input current 1A/5A, X/1A, X/5A, Input voltage 3x230/400V, Measuring class A/S, Ethernet, RS485, USB interfaces, memory up to 32GB, supply 85-253V a.c. or 90-300V d.c., documentation and descriptions in Polish and English version, test certificate

\* Upon agreement, an option to order a calibration certificate for the product is available against payment. Then, in the execution code, in the place of the last character, enter the digit **2**, e.g. **ND45 2011M002**. The customer will then receive a standard test certificate and a calibration certificate (against payment).



**LUMEL S.A.**

ul. Słubicka 4, 65-127 Zielona Góra, Poland  
tel.: +48 68 45 75 100, fax +48 68 45 75 508  
[www.lumel.com.pl](http://www.lumel.com.pl)

**Technical support:**

tel.: (+48 68) 45 75 143, 45 75 141, 45 75 144, 45 75 140  
e-mail: [export@lumel.com.pl](mailto:export@lumel.com.pl)

**Export department:**

tel.: (+48 68) 45 75 130, 45 75 132  
e-mail: [export@lumel.com.pl](mailto:export@lumel.com.pl)

**Calibration & Attestation:**

e-mail: [laboratorium@lumel.com.pl](mailto:laboratorium@lumel.com.pl)